



2026
Edition

SUNIKOO
GLASS & HARDWARE

HARDWARE CATALOG

Welcome to UNIKOO Glass & Hardware

At UNIKOO, we're thrilled to embark on a journey with you, redefining the glass and hardware experience for the Shower Door Enclosure and Commercial Railing industries. Based in California, our privately owned company proudly serves the Glass, General Contractors, and Kitchen and Tile industries with a smile and a commitment to excellence.

Our Offerings

We cater to a wide range of projects—from cozy homes to bustling commercial storefronts and chic apartment complexes to luxurious hotels. No matter the vision, UNIKOO is here to bring it to life, offering a diverse selection of products in numerous finishes. The possibilities with us are truly endless!

Our Experience

Our team brings over 60 years of technical expertise, ready to support and guide your project to success. Since our inception in 2017 in a modest 2,800 sq. ft. office, we've expanded dramatically. Today, we proudly operate over 60,000 sq. ft. of manufacturing space and manage three strategic locations in Southern California and New Jersey. With over 100,000 sq. ft. of warehouse distribution space nationwide, we're poised as an industry leader eager to serve every corner of the country.

Our Products

Explore our superb product range, featuring impeccable stock and custom-size glass, elegant shower enclosure units, stylish hand railing and entrance hardware for residential and commercial spaces, and essential accessories to finish your project with flair. Whether you visit us in person or browse online, you'll find quality that speaks for itself.

Our Commitment

UNIKOO is dedicated to providing top-quality glass solutions with a strong focus on innovation and efficiency. We take pride in delivering premium shower doors and glass products that combine durability, aesthetics, and precision craftsmanship. Our commitment to excellence ensures that every project meets the highest industry standards, while our innovative approach allows us to stay ahead of trends and customer needs. With a fast turnaround time, we prioritize reliability and customer satisfaction, ensuring that our clients receive exceptional products and service without delay. At UNIKOO, quality and efficiency go hand in hand.



Our Vision

To be a leading provider of glass and hardware solutions, recognized for our unwavering commitment to customers, continuous innovation, quality-driven products, and a collaborative culture that drives success and growth.



Our Mission

To deliver exceptional glass and hardware solutions by upholding customer commitment, fostering creativity in every innovation, crafting value through quality and reliability, and promoting collaboration across all teams to achieve success together, driven by excellence.



Our Core Values

- Customer Commitment-Always prioritize the needs and satisfaction of our customers.
- Creativity-Embrace innovation and continuous improvement in everything we do.
- Crafting Value - Focus on providing high-quality solutions that offer real value to our customers.
- Collaboration-Work together, support each other, and achieve success as one.



Commercial Product

Commercial Handrail Hardware	04-21
Commercial Clamps	22-23
Commercial Door Stop / Pulls	23-24
Commercial Locks / Handles / Door Patch	25
Commercial Door Patch Hardware	26-29
Commercial Door Hardware Sets	30-31

Sliding Door

Sliding Door Units.....	32-40
Photo Gallery	41-43
Plastic Seals	44-45

Swing Door Accessories

Standard Hinges	46-49
Heavy Duty Hinges	49-54
Glass Clamps.....	54-59
Shower Door Header Accessories	60-61
U Channel / J Channel / L Profile	62-63
Glass Support Bars.....	64
Handles / Towel Bars	65-70
Door Knobs	70-73
Robe Hooks.....	73

Accessories

Sealants / Cleaners	74
Accessories	75-78
Stock Mirror	79-80

120" Square Dry Glaze Base Shoe Set - Drilled

- Includes base shoe, 2pcs. cladding, and dry glaze blocks.
- For 1/2" to 9/16" laminated tempered glass

Item #	Finish	Pack
CBSA120D-CH	Chrome	1 Set
CBSA120D-BN	Brushed Nickel	1 Set
CBSA120D-MBL	Matte Black	1 Set

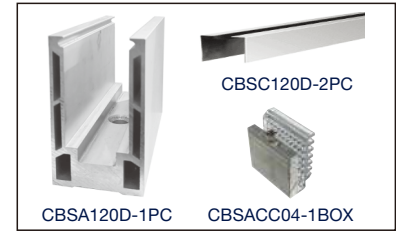

120"/240" Square Dry Glaze Base Shoe - 1/2" Glass - Drilled

- For 1/2" laminated tempered glass
- Base shoe only - drilled

Item #	Length	Pack
CBSA120D	120"	1 Pc.



120" Straight Cladding for Dry Glaze Base Shoe

- Straight cladding for 120" long dry glaze base shoe
- 316 Stainless steel

Item #	Finish	Pack
CBSC120D-CH	Chrome	1 Pc.
CBSC120D-BN	Brushed Nickel	1 Pc.
CBSC120D-MBL	Matte Black	1 Pc.

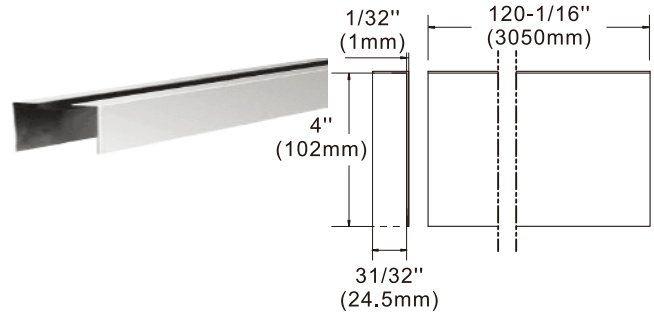

Dry Glaze Base Shoe Blocks

- Includes 9 sets of blocks for dry glaze base shoe

Item #	Pack
CBSACC04	9 Sets/Box



120" Heavy Duty Square Wet Glaze Base Shoe Set for 1/2" Glass - Drilled

- Includes base shoe, claddings, and base shoe blocks
- For use with 1/2" (12 mm) monolithic tempered glass

Item #	Finish	Pack
CBSAH120SET-BN	Brushed Nickel	1 Set
CBSAH120SET-MBL	Matte Black	1 Set

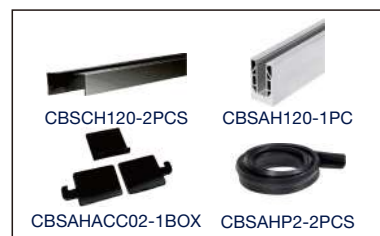

120"/240" Heavy Duty Square Wet Glaze Base Shoe for 1/2" Glass

- For 1/2" laminated tempered glass
- Base shoe only - drilled

Item #	Length	Pack
CBSAH120	120"	1 Pc.



120" Straight Cladding for Heavy Duty Wet Glaze Base Shoe

- Adhere with cladding tape or silicone sealant
- 316 Stainless steel

Item #	Finish	Pack
CBSCH120-BN	Brushed Nickel	1 Pc.
CBSCH120-MBL	Matte Black	1 Pc.

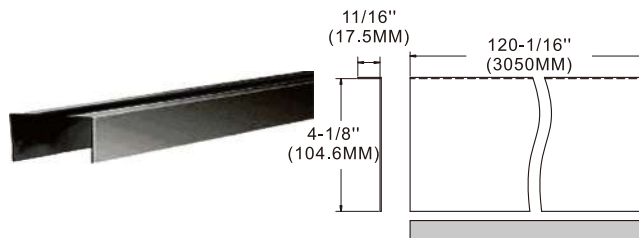

Wet Glaze Base Shoe Blocks (9 sets)

- Includes 9 sets of accessories for 120" base shoe

Item #	Pack
CBSAHACC02	9 Sets/Box



Black Rubber Gasket for CBSAH (2 pcs) - 120"

- length: 120"

Item #	Pack
CBSAHP2	2 Pcs.



Base Shoe End Cap

- Stainless end cap for CBS series standard square base shoe

Item #	Finish	Pack
CRRCAP01-CH	Chrome	1 Pc./Box
CRRCAP01-BN	Brushed Nickel	1 Pc./Box
CRRCAP01-MBL	Matte Black	1 Pc./Box



8" 90 Degree Mitered Heavy Duty Wet Glaze Corner Base Shoe

- For 1/2" tempered glass
- Base shoe only

Item #	Pack
CBSH90C	1 Pc.



8" 90 Degree Mitered Dry Glaze Corner Base Shoe

- For 1/2" tempered glass
- Base shoe only

Item #	Pack
CBS90C	1 Pc.



4-5/8" Concrete Screw for Heavy Duty Base Shoe

- Concrete screw for heavy duty wet glaze base shoe CBSAH and heavy duty base shoe CBSA

Item #	Pack
CBSAHACC03	1 Pc.



5" Concrete Screw for Base Shoe

- Concrete screw for regular base shoe

Item #	Pack
CBSACC05	1 Pc.



10" Square Surface Mount Post Clamp (Spigot)

- Includes gaskets for use with 3/8", 1/2" and 9/16" glass
- Mount screws or bolts sold separately
- Duplex 2205 stainless steel
- No glass fabrication required

Item #	Finish	Pack
CWS09CP-CH	Chrome	1 Pc./Box
CWS09CP-BN	Brushed Nickel	1 Pc./Box
CWS09CP-MBL	Matte Black	1 Pc./Box



12" Tilt Lock Adjustable Fascia Mount Post Clamp (Spigot)

- For 1/2" thick glass
- Allows up to 2-3 degree of glass adjustment
- Duplex 2205 stainless steel
- No glass fabrication required
- Includes 2 Concrete bolts (M10*5")

Item #	Finish	Pack
CWS10CP-01-CH	Chrome	1 Pc./Box
CWS10CP-01-BN	Brushed Nickel	1 Pc./Box
CWS10CP-01-MBL	Matte Black	1 Pc./Box



6-3/8" Square Adjustable Surface Mount Post Clamp (Spigot)

- Duplex 2205 stainless steel
- Height: 6 3/8"
- Friction fit suitable for 3/8"-1/2" (10mm-12mm) tempered glass
- No glass fabrication required

Item #	Finish	Pack
CWS11CP-ADJ-CH	Chrome	1 Pc./Box
CWS11CP-ADJ-BN	Brushed Nickel	1 Pc./Box
CWS11CP-ADJ-MBL	Matte Black	1 Pc./Box
CWS11CP-ADJ-SB	Satin Brass	1 Pc./Box



6-3/8" Round Surface Mount Post Clamp (Spigot)

- Duplex 2205 stainless steel
- Height: 6 3/8"
- Friction fit suitable for 3/8"-1/2" (10mm-12mm) tempered glass
- No glass fabrication required

Item #	Finish	Pack
CWS12CP-CH	Chrome	1 Pc./Box
CWS12CP-BN	Brushed Nickel	1 Pc./Box
CWS12CP-MBL	Matte Black	1 Pc./Box



6-3/16" Oval Base Top Mount Post Clamp (Spigot)

- For 3/8" - 1/2" thick glass
- Duplex 2205 stainless steel
- No glass fabrication required

Item #	Finish	Pack
CWS13CP-CH	Chrome	1 Pc./Box
CWS13CP-BN	Brushed Nickel	1 Pc./Box
CWS13CP-MBL	Matte Black	1 Pc./Box



5-5/16" Edge Mount Post Clamp

- For 1/2" thick glass
- Allows up to 2 - 3 degree of glass adjustment
- No glass fabrication required
- Includes gaskets, screws, and template

Item #	Finish	Pack
CWS14CP-01-CH	Chrome	1 Pc./Box
CWS14CP-01-BN	Brushed Nickel	1 Pc./Box
CWS14CP-01-MBL	Matte Black	1 Pc./Box



8-7/8" Square Surface Mount Post Clamp for Bevel Stairs (Spigot)

- For 1/2" thick glass
- Includes base cover and gaskets
- The adjustable angle range is 35-45 degrees

Item #	Finish	Pack
CWS22CP-CH	Chrome	1 Pc./Box
CWS22CP-BN	Brushed Nickel	1 Pc./Box
CWS22CP-MBL	Matte Black	1 Pc./Box



Glass Rail Standoff Base And Cap - 2" Diameter x 1-3/4" Projection

- For use with 1/2" & 3/4" (12 & 19mm) monolithic tempered glass or 9/16" and 27/32" (13.52 & 21.52mm) laminated tempered glass

Item #	Finish	Pack
CSS11CP-CH	Chrome	1 Pc./Box
CSS11CP-BN	Brushed Nickel	1 Pc./Box
CSS11CP-MBL	Matte Black	1 Pc./Box
CSS11CP-SB	Satin Brass	1 Pc./Box



Standard 2" Glass Rail Standoff Fitting with Mounting Plate

- 316 stainless steel
- Glass fabrication: two 3/4" (19mm) diameter hole per fitting

Item #	Finish	Pack
CSS12CP-CH	Chrome	1 Pc./Box
CSS12CP-BN	Brushed Nickel	1 Pc./Box
CSS12CP-MBL	Matte Black	1 Pc./Box



Glass Rail Standoff Base And Cap - 2" Diameter x 1" Projection

- For use with 1/2" & 3/4" (12 & 19mm) monolithic tempered glass or 9/16" and 27/32" (13.52 & 21.52mm) laminated tempered glass

Item #	Finish	Pack
CSS13CP-CH	Chrome	1 Pc./Box
CSS13CP-BN	Brushed Nickel	1 Pc./Box
CSS13CP-MBL	Matte Black	1 Pc./Box
CSS13CP-SB	Satin Brass	1 Pc./Box



Glass Rail Square Standoff Base And Cap - 2" x 2" x 1" Projection

- For use with 1/2" - 13/16" thick glass

Item #	Finish	Pack
CSS14CP-CH	Chrome	1 Pc./Box
CSS14CP-BN	Brushed Nickel	1 Pc./Box
CSS14CP-MBL	Matte Black	1 Pc./Box

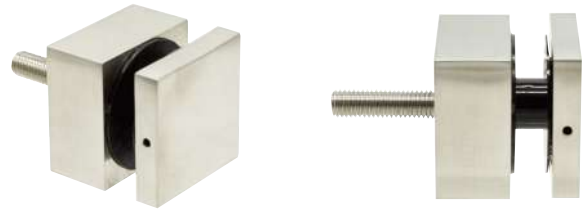

Adjustable Glass Rail Standoff Base and Cap - 2-5/16" Projection

- For Use with 1/2" (12 mm) Monolithic Tempered Glass or 1/2" (12 mm) Laminated Tempered Glass

Item #	Finish	Pack
CSS17CPADJ-CH	Chrome	1 Pc./Box
CSS17CPADJ-BN	Brushed Nickel	1 Pc./Box
CSS17CPADJ-MBL	Matte Black	1 Pc./Box



Round Post Flange Cover

- Design to cover 1 1/4" pipe rail
- 1" Standard height

Item #	Finish	Pack
CRS11FG-CH	Chrome	1 Pc./Box
CRS11FG-BN	Brushed Nickel	1 Pc./Box
CRS11FG-MBL	Matte Black	1 Pc./Box

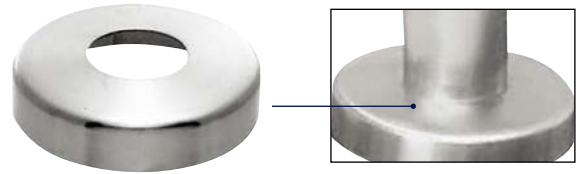

Square Post Flange Cover

- Design to cover 5" x 5" welded flanges on 2" outside diameter square tube
- 1" (25.4 mm) standard height

Item #	Finish	Pack
CRS12FG-CH	Chrome	1 Pc./Box
CRS12FG-BN	Brushed Nickel	1 Pc./Box
CRS12FG-MBL	Matte Black	1 Pc./Box



Round 2" U-Shaped Flange

- Full flange for 2" tubing

Item #	Finish	Pack
CRS17FG-CH	Chrome	1 Pc./Box
CRS17FG-BN	Brushed Nickel	1 Pc./Box
CRS17FG-MBL	Matte Black	1 Pc./Box



Round 2" Full Flange

- Full flange for 2" tubing

Item #	Finish	Pack
CRS18FG-CH	Chrome	1 Pc./Box
CRS18FG-BN	Brushed Nickel	1 Pc./Box
CRS18FG-MBL	Matte Black	1 Pc./Box



Square Flange

- Square full flange for 1 1/2" tubing

Item #	Finish	Pack
CRS30FG-BN	Brushed Nickel	1 Pc./Box
CRS30FG-MBL	Brushed Nickel	1 Pc./Box



Flat End Cap

- Flat end cap for 2" round tubing
- Required end caps and connector sleeves (sold separately)

Item #	Finish	Pack
CRS13CAP-CH	Chrome	1 Pc.
CRS13CAP-BN	Brushed Nickel	1 Pc.
CRS13CAP-MBL	Matte Black	1 Pc.



2" Round End Cap

- End cap for 2" cap railing

Item #	Finish	Pack
CRS14CAP-CH	Chrome	1 Pc./Box
CRS14CAP-BN	Brushed Nickel	1 Pc./Box
CRS14CAP-MBL	Matte Black	1 Pc./Box

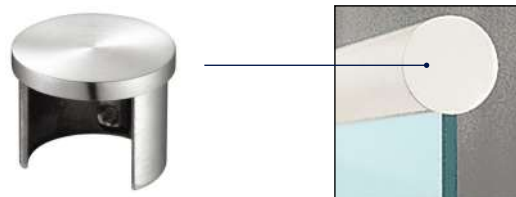

2" Dome End Cap

- Dome End cap for 2" cap railing

Item #	Finish	Pack
CRS43CAP-CH	Chrome	1 Pc./Box
CRS43CAP-CH	Brushed Nickel	1 Pc./Box
CRS43CAP-CH	Matte Black	1 Pc./Box



Square Flat End Cap

- SS316 stainless steel
- Square end cap for 1-9/16" square tubing

Item #	Finish	Pack
CRS36CP-BN	Brushed Nickel	1 Pc./Box
CRS36CP-MBL	Matte Black	1 Pc./Box
CRS36CP-WG	Wood Grain	1 Pc./Box



Commercial -Square End Cap

- SS316 stainless steel
- For 1-9/16" square cap rail

Item #	Finish	Pack
CRS15SCAP-BN	Brushed Nickel	1 Pc./Box
CRS15SCAP-MBL	Matte Black	1 Pc./Box
CRS15SCAP-WG	Wood Grain	1 Pc./Box

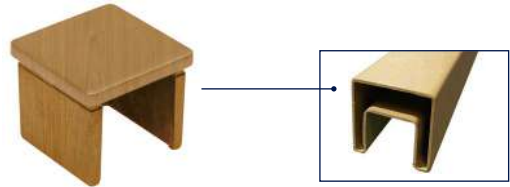

Commercial -In-line Connector

- SS316 stainless steel
- For 1-9/16" square cap rail

Item #	Finish	Pack
CRS30SCT-BN	Brushed Nickel	1 Pc./Box
CRS30SCT-MBL	Matte Black	1 Pc./Box
CRS30SCT-WG	Wood Grain	1 Pc./Box



Commercial - 90 Degree Connector

- SS316 stainless steel
- For 1-9/16" square cap rail

Item #	Finish	Pack
CRS31SCT-BN	Brushed Nickel	1 Pc./Box
CRS31SCT-MBL	Matte Black	1 Pc./Box
CRS31SCT-WG	Wood Grain	1 Pc./Box



Commercial -Adjustable Connector

- SS316 stainless steel
- For 1-9/16" square cap rail

Item #	Finish	Pack
CRS43SCT-BN	Brushed Nickel	1 Pc./Box
CRS43SCT-MBL	Matte Black	1 Pc./Box
CRS43SCT-WG	Wood Grain	1 Pc./Box



90 Degree Square Miter Corner

- SS316 stainless steel
- Suitable for square 1-9/16" tubing - CRS12RL

Item #	Finish	Pack
CRS31FT-BN	Brushed Nickel	1 Pc./Box
CRS31FT-MBL	Matte Black	1 Pc./Box
CRS31FT-WG	Wood Grain	1 Pc./Box



180 Degree Square 2-Way Connector

- Suitable for 1-9/16" square tubing - CRS12RL
- SS316 stainless steel

Item #	Finish	Pack
CRS32FT-BN	Brushed Nickel	1 Pc./Box
CRS32FT-MBL	Matte Black	1 Pc./Box
CRS32FT-WG	Wood Grain	1 Pc./Box



2" 90 Degree Miter Corner

- Mitered 90 degree corner for 2" tubing

Item #	Finish	Pack
CRS25FT-CH	Chrome	1 Pc./Box
CRS25FT-BN	Brushed Nickel	1 Pc./Box
CRS25FT-MBL	Matte Black	1 Pc./Box

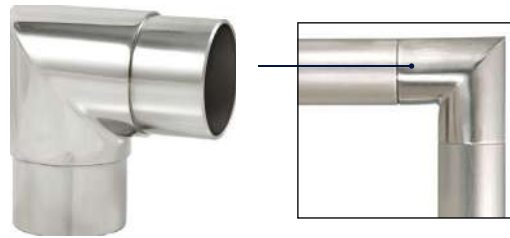

2" 90 Degree Flush Angle End Cap

- 90 degree flush angle end for 2" tubing

Item #	Finish	Pack
CRS26FT-CH	Chrome	1 Pc./Box
CRS26FT-BN	Brushed Nickel	1 Pc./Box
CRS26FT-MBL	Matte Black	1 Pc./Box

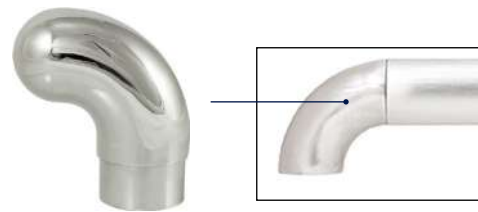

2" 180 Degree 2-Way Connector

- 180 degree 2-way connector for 2" tubing

Item #	Finish	Pack
CRS12FT-CH	Chrome	1 Pc.
CRS12FT-BN	Brushed Nickel	1 Pc.
CRS12FT-MBL	Matte Black	1 Pc.



2" Adjustable Connector

- Adjustable connector for 2" tubing

Item #	Finish	Pack
CRS33FT-CH	Chrome	1 Pc./Box
CRS33FT-BN	Brushed Nickel	1 Pc./Box
CRS33FT-MBL	Matte Black	1 Pc./Box



Square Flush Tee Connector

- Square flush tee for square tubing

Item #	Finish	Pack
CRS34FT-BN	Brushed Nickel	1 Pc./Box
CRS34FT-MBL	Matte Black	1 Pc./Box



90 Degree Square Side Outlet Elbow Connector

- 90 degree square side outlet elbow for square tubing

Item #	Finish	Pack
CRS35FT-BN	Brushed Nickel	1 Pc./Box
CRS35FT-MBL	Matte Black	1 Pc./Box



180 Degree Cap Rail Connector

- Connects to 3" cap rail

Item #	Finish	Pack
CRS27CT-CH	Chrome	1 Pc./Box
CRS27CT-BN	Brushed Nickel	1 Pc./Box
CRS27CT-MBL	Matte Black	1 Pc./Box



Cap Rail 90 Degree Connector

- Connects with 2" cap rail

Item #	Finish	Pack
CRS28CT-CH	Chrome	1 Pc./Box
CRS28CT-BN	Brushed Nickel	1 Pc./Box
CRS28CT-MBL	Matte Black	1 Pc./Box



2" Round Adjustable Connector

- Adjusts 0-70 degrees downward

Item #	Finish	Pack
CRS42CTU-CH	Chrome	1 Pc./Box
CRS42CTU-BN	Brushed Nickel	1 Pc./Box
CRS42CTU-MBL	Matte Black	1 Pc./Box



1-1/2" Square Adjustable Cap Rail Connector

- For 1-1/2" x 1-1/2" cap rail

Item #	Finish	Pack
CRS45CT-BN	Brushed Nickel	1 Pc./Box
CRS45CT-MBL	Matte Black	1 Pc./Box

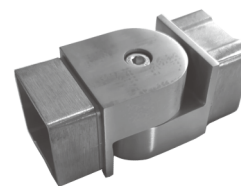

2" Extruded Cap Rail For 1/2" Glass - 120"

- Includes plastic insert
- 316 stainless steel

Item #	Finish	Pack
CRS13CR-120-CH	Chrome	1 Pc.
CRS13CR-120-BN	Brushed Nickel	1 Pc.
CRS13CR-120-MBL	Matte Black	1 Pc.



Commercial -Square Cap Rail For 1-2" Glass - 120"

- SS316 stainless steel
- For 1-9/16" square tubing
- Includes plastic insert

Item #	Finish	Pack
CRS15SCR-120-BN	Brushed Nickel	1 Pc./Box
CRS15SCR-120-MBL	Matte Black	1 Pc./Box
CRS15SCR-120-WG	Wood Grain	1 Pc./Box



1-9/16" Square Tubing - 120"

- 1-9/16" square tubing
- 120" long
- SS316 stainless steel

Item #	Finish	Pack
CRS12RL-120-BN	Brushed Nickel	1 Pc.
CRS12RL-120-MBL	Matte Black	1 Pc.
CRS12RL-120-WG	Wood Grain	1 Pc.



2" Tubing - 120"

- 2" diameter round .050" tubing
- 120" long

Item #	Finish	Pack
CRS11RL-120-CH	Chrome	1 Pc.
CRS11RL-120-BN	Brushed Nickel	1 Pc.
CRS11RL-120-MBL	Matte Black	1 Pc.



60" CAP RAIL INSERT

- For 3/4" glass

Item #	Pack
CRS31RI-60	1 Pc./Box



60" CAP RAIL INSERT

- For 5/8" glass

Item #	Pack
CRS30RI-60	1 Pc./Box



Flat Handrail Adapter Plate

- Adapter plate for flat handrail

Item #	Finish	Pack
CRSADPT-01	Brushed Nickel	1 Pc./Box



Glass Mount Hand Rail Bracket With Radws Saddle

- For 1 1/2", 1.9", or 2" (38, 48, or 51mm) diameter hand rail tubing
- For 1/2" to 1 1/16" (12 to 25.52mm) glass thickness

Item #	Finish	Pack
CRS11BK-CH	Chrome	1 Pc./Box
CRS11BK-BN	Brushed Nickel	1 Pc./Box
CRS11BK-MBL	Matte Black	1 Pc./Box



Wall Mount Hand Rail Bracket With Radws Saddle

- For 1 1/2", 1.9", or 2" (38, 48, or 51mm) diameter hand rail tubing
- For 1/2" to 1 1/16" (12 to 25.52mm) glass thickness

Item #	Finish	Pack
CRS12BK-CH	Chrome	1 Pc./Box
CRS12BK-BN	Brushed Nickel	1 Pc./Box
CRS12BK-MBL	Matte Black	1 Pc./Box



Long Arm Wall Bracket With Radws Saddle

- Hand railing bracket for 1.9" & 2" (48 & 51mm) tubing

Item #	Finish	Pack
CRS15BK-CH	Chrome	1 Pc./Box
CRS15BK-BN	Brushed Nickel	1 Pc./Box
CRS15BK-MBL	Matte Black	1 Pc./Box



Concealed Surface Mount Hand Railing Bracket With Radws Saddle

- Concealed surface mount hand railing bracket for 1.9" & 2" (48 & 51mm) tubing

Item #	Finish	Pack
CRS16BK-CH	Chrome	1 Pc./Box
CRS16BK-BN	Brushed Nickel	1 Pc./Box
CRS16BK-MBL	Matte Black	1 Pc./Box

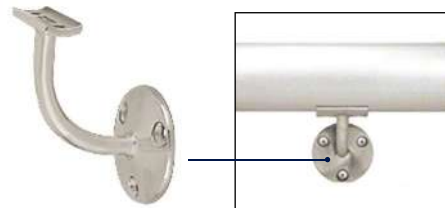

2" Straight Saddle

- Straight saddle for 2" tubing

Item #	Finish	Pack
CRS18SD-CH	Chrome	1 Pc./Box
CRS18SD-BN	Brushed Nickel	1 Pc./Box
CRS18SD-MBL	Matte Black	1 Pc./Box



2" Radius Adjustable Saddle

- Designed to attach to round style hand rails 1 1/2" to 2" (38 to 51mm) in diameter
- Includes mounting screws
- For 2" (51mm) diameter tubing

Item #	Finish	Pack
CRS19SD-CH	Chrome	1 Pc./Box
CRS19SD-BN	Brushed Nickel	1 Pc./Box
CRS19SD-MBL	Matte Black	1 Pc./Box



Commercial - Square Wall Mount Bracket

- For 1-1/2"x1-1/2" (40mm*40mm) (CRS12RL) square handrail tubing

Item #	Finish	Pack
CRS16SBK-WG	Wood Grain	1 Pc./Box



Square Straight Saddle

- Straight saddle
- For 1 1/2" square tubing

Item #	Finish	Pack
CRS37SD-BN	Brushed Nickel	1 Pc./Box



Adjustable Square Straight Saddle

- Straight saddle
- For 1 1/2" square tubing

Item #	Finish	Pack
CRS37SD-ADJ-BN	Brushed Nickel	1 Pc./Box
CRS37SD-ADJ-MBL	Matte Black	1 Pc./Box



2" 90 Degree Side Outlet Elbow Connector

- 90 degree side outlet elbow for 2" tubing

Item #	Finish	Pack
CRS22FT-CH	Chrome	1 Pc./Box
CRS22FT-BN	Brushed Nickel	1 Pc./Box
CRS22FT-MBL	Matte Black	1 Pc./Box



2" Flush Tee Connector

- Flush tee for 2" tubing

Item #	Finish	Pack
CRS23FT-CH	Chrome	1 Pc./Box
CRS23FT-BN	Brushed Nickel	1 Pc./Box
CRS23FT-MBL	Matte Black	1 Pc./Box

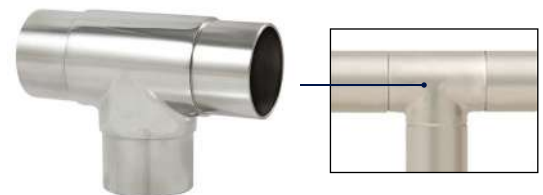

2" 135 Degree Flush Angle Connector

- 135 Degree flush angle for 2" tubing

Item #	Finish	Pack
CRS24FT-CH	Chrome	1 Pc./Box
CRS24FT-BN	Brushed Nickel	1 Pc./Box
CRS24FT-MBL	Matte Black	1 Pc./Box

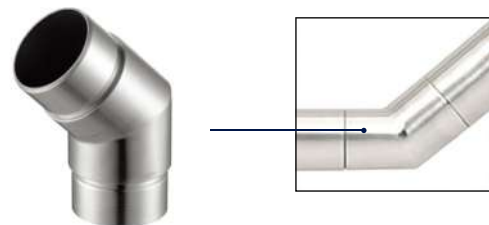

1-1/2" Height U Channel - 120"/240"

- 120"/240" long, 1-1/2" height U channel
- For 1/2" - 9/16" thick glass
- Aluminum

Item #	Finish	Pack
CUCN-1-1/2"-120/240-CH	Chrome	1 Pc.
CUCN-1-1/2"-120/240-BN	Brushed Nickel	1 Pc.
CUCN-1-1/2"-120/240-MBL	Matte Black	1 Pc.
CUCN-1-1/2"-120/240-SB	Satin Brass	1 Pc.
CUCN-1-1/2"-120/240-SA	Satin Anodized	1 Pc.



2" Height U Channel - 120"/240"

- 120"/240" long, 2" height U channel
- For 1/2" - 9/16" thick glass
- Aluminum

Item #	Finish	Pack
CUCN-2"-120/240-CH	Chrome	1 Pc.
CUCN-2"-120/240-BN	Brushed Nickel	1 Pc.
CUCN-2"-120/240-MBL	Matte Black	1 Pc.
CUCN-2"-120/240-SB	Satin Brass	1 Pc.
CUCN-2"-120/240-SA	Satin Anodized	1 Pc.



1-1/2" Deep End Cap for 120"/240" U Channel

- Covers open end of 1-1/2" deep U channel
- Aluminum

Item #	Finish	Pack
CUCN-1-EC-CH	Chrome	1 Pc.
CUCN-1-EC-BN	Brushed Nickel	1 Pc.
CUCN-1-EC-MBL	Matte Black	1 Pc.
CUCN-1-EC-SB	Satin Brass	1 Pc.



2" Deep End Cap for 120"/240" U Channel

- Covers open end of 2" deep U channel
- Aluminum

Item #	Finish	Pack
CUCN-2-EC-CH	Chrome	1 Pc.
CUCN-2-EC-BN	Brushed Nickel	1 Pc.
CUCN-2-EC-MBL	Matte Black	1 Pc.
CUCN-2-EC-SB	Satin Brass	1 Pc.



M4 Steel Cable

- Sold by foot
- 100ft or bulk 300ft rolls

Item #	Finish	Pack
CWR01RP-BN	Brushed Nickel	1 Pc./Box



M4 Wire Rope Lock

- Wire rope lock for steel cable

Item #	Finish	Pack
CWR04LK	Brushed Nickel	1 Pc./Box



Screws for Commercial Hardware



CWSCPACC01

**4" Hardwood Screw
for Surface Mount Post Clamp**



CWSCPACC02

**4" Flat Head Concrete Screw
for Surface Mount Post Clamp**



CWSCPACC03

**3" Hardwood Screw
for Surface Mount Post Clamp**



CSS-CA

**4" Round Head Concrete Screw
for Surface Mount Post Clamp**



CSS11CPACC01

**3" Wood Screw
for Standoff Base**



CSS11CPACC02

**4" Wood Screw
for Standoff Base**



CBSACC02

**3/8"-16 X 4" Socket Flat Head Wood Screws
for Standoff Base Shoe (9pcs)**



CSHCS12X34

**Stainless Steel 1/2-13 X 3/4"
Socket Head Cap Screw**

Wire Rope Post - 180 Degree Center / End

- 180 degree wire rope post clamp
- Includes top flat saddle

Item #	Finish	Pack
CWR02PT-BN	Brushed Nickel	1 Pc./Box
CWR02PT-MBL	Matte Black	1 Pc./Box



Wire Rope Post - 90 Degree Corner

- 180 degree wire rope post
- Includes top flat saddle

Item #	Finish	Pack
CWR03PT-BN	Brushed Nickel	1 Pc./Box
CWR03PT-MBL	Matte Black	1 Pc./Box



Center Post

- Available in 44"/44 - 1/4" (overall) height
- For 3/8" - 1/2" glass

Item #	Finish	Pack
CNR01PT-44-1/4-BN	Brushed Nickel	1 Pc./Box
CNR01PT-44-1/4-MBL	Matte Black	1 Pc./Box

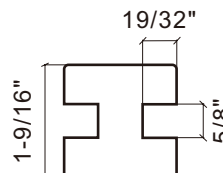

End Post

- Available in 44"/44 - 1/4" (overall) height
- For 3/8" - 1/2" glass

Item #	Finish	Pack
CNR02PT-44-1/4-BN	Brushed Nickel	1 Pc./Box
CNR02PT-44-1/4-MBL	Matte Black	1 Pc./Box

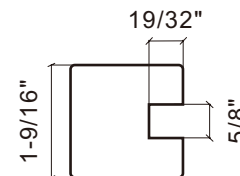

90 Degree Corner Post

- Available in 44"/44 - 1/4" (overall) height
- For 3/8" - 1/2" glass

Item #	Finish	Pack
CNR03PT-44-1/4-BN	Brushed Nickel	1 Pc./Box
CNR03PT-44-1/4-MBL	Matte Black	1 Pc./Box

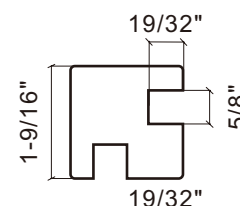

Square End Post

- Single sided glass clamp post
- For 3/8" - 1/2" clamps
- Includes top flat saddle

Item #	Finish	Pack
CRS39GC-BN	Brushed Nickel	1 Pc./Box
CRS39GC-MBL	Matte Black	1 Pc./Box

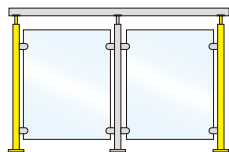

Square 90 Degree Corner Post

- 90 degree glass clamp post
- For 3/8" - 1/2" clamps
- Includes top flat saddle

Item #	Finish	Pack
CRS40GC-BN	Brushed Nickel	1 Pc./Box
CRS40GC-MBL	Matte Black	1 Pc./Box

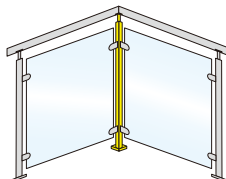

Square 180 Degree Center Post

- 180 degree bilateral glass clamp post
- For 3/8" - 1/2" clamps
- Includes top flat saddle

Item #	Finish	Pack
CRS41GC-BN	Brushed Nickel	1 Pc./Box
CRS41GC-MBL	Matte Black	1 Pc./Box

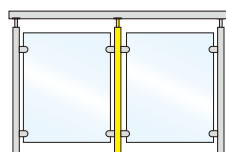

Round End Post

- 42-3/4" total height
- For 3/8" - 1/2" radius back clamps
- Includes top flat saddle

Item #	Finish	Pack
CRS39GCR-BN	Brushed Nickel	1 Pc./Box
CRS39GCR-MBL	Matte Black	1 Pc./Box

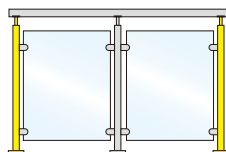

Round 90 Degree Corner Post

- 42-3/4" total height
- For 3/8" - 1/2" radius back clamps
- Includes top flat saddle

Item #	Finish	Pack
CRS40GCR-BN	Brushed Nickel	1 Pc./Box
CRS40GCR-MBL	Matte Black	1 Pc./Box

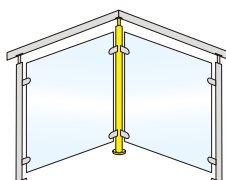

Round 180 Degree Center Post

- 42-3/4" total height
- For 3/8" - 1/2" radius back clamps
- Includes top flat saddle

Item #	Finish	Pack
CRS41GCR-BN	Brushed Nickel	1 Pc./Box
CRS41GCR-MBL	Matte Black	1 Pc./Box

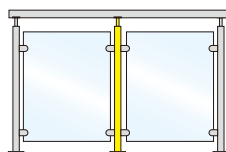

Square Flat Base Glass Clamp

- 2-3/16"x1"
- For 3/8" - 1/2" glass

Item #	Finish	Pack
CRS13CP-CH	Chrome	1 Pc./Box
CRS13CP-BN	Brushed Nickel	1 Pc./Box
CRS13CP-MBL	Matte Black	1 Pc./Box



Round Flat Base Glass Clamp

- 2-3/16"x1"
- For 3/8" - 1/2" glass

Item #	Finish	Pack
CRS14CP-CH	Chrome	1 Pc./Box
CRS14CP-BN	Brushed Nickel	1 Pc./Box
CRS14CP-MBL	Matte Black	1 Pc./Box



Round Radius Base Glass Clamp

- 2-3/16"x1"
- For 1/2" glass

Item #	Finish	Pack
CRS15CP-CH	Chrome	1 Pc./Box
CRS15CP-BN	Brushed Nickel	1 Pc./Box
CRS15CP-MBL	Matte Black	1 Pc./Box



Wall Mount Glass Bracing Clamp

- Does not require holes in the glass
- Provide extra stability and rigidity for glass panels
- For 3/8" to 1/2" glass

Item #	Finish	Pack
CWS15CP-CH	Chrome	1 Pc./Box
CWS15CP-BN	Brushed Nickel	1 Pc./Box
CWS15CP-MBL	Matte Black	1 Pc./Box
CWS15CP-SB	Satin Brass	1 Pc./Box



90 Degree Glass Bracing Clamp

- Does not require holes in the glass
- Provide extra stability and rigidity for glass panels
- For 3/8" to 1/2" glass

Item #	Finish	Pack
CWS16CP-CH	Chrome	1 Pc./Box
CWS16CP-BN	Brushed Nickel	1 Pc./Box
CWS16CP-MBL	Matte Black	1 Pc./Box
CWS16CP-SB	Satin Brass	1 Pc./Box



180 Degree Glass Bracing Clamp

- Does not require holes in the glass
- Provide extra stability and rigidity for glass panels
- For 3/8" to 1/2" glass

Item #	Finish	Pack
CWS17CP-CH	Chrome	1 Pc./Box
CWS17CP-BN	Brushed Nickel	1 Pc./Box
CWS17CP-MBL	Matte Black	1 Pc./Box
CWS17CP-SB	Satin Brass	1 Pc./Box



Adjustable Glass-to-Glass Bracing Clamp

- Does not require holes in the glass
- Provide extra stability and rigidity for glass panels
- For 3/8" to 1/2" glass

Item #	Finish	Pack
CWS18CP-CH	Chrome	1 Pc./Box
CWS18CP-BN	Brushed Nickel	1 Pc./Box
CWS18CP-MBL	Matte Black	1 Pc./Box
CWS18CP-SB	Satin Brass	1 Pc./Box

180 DEGREE



Wall Mount Glass Bracing Clamp

- Does not require holes in the glass
- For 1/2" glass

Item #	Finish	Pack
CWS19CP-CH	Chrome	1 Pc./Box
CWS19CP-BN	Brushed Nickel	1 Pc./Box
CWS19CP-MBL	Matte Black	1 Pc./Box



4"x2" 180 Degree Glass Bracing Clamp

- Does not require holes in the glass
- For 1/2" glass

Item #	Finish	Pack
CWS20CP-CH	Chrome	1 Pc./Box
CWS20CP-BN	Brushed Nickel	1 Pc./Box
CWS20CP-MBL	Matte Black	1 Pc./Box



3"x2" 90 Degree Glass Bracing Clamp

- Does not require holes in the glass
- For 1/2" glass

Item #	Finish	Pack
CWS21CP-CH	Chrome	1 Pc./Box
CWS21CP-BN	Brushed Nickel	1 Pc./Box
CWS21CP-MBL	Matte Black	1 Pc./Box



Floor Mounted Dome Style Door Stop

- Low profile base
- 1-3/4" heavy cast with vinyl bomper

Item #	Finish	Pack
CDS2501-CH	Chrome	1 Pc./Box
CDS2501-BN	Brushed Nickel	1 Pc./Box
CDS2501-MBL	Matte Black	1 Pc./Box



Ladder Pull Back-To-Back Handle With Lock - 48"

- 36" CTC hole spacing, 48" total length
- Deadbolt locking mechanism

Item #	Finish	Pack
CHLL48X48-CH	Chrome	1 Pc./Box
CHLL48X48-BN	Brushed Nickel	1 Pc./Box
CHLL48X48-MBL	Matte Black	1 Pc./Box



Ladder Pull Back-To-Back Handle With Lock - 60"

- 48" CTC hole spacing, 60" total length
- Deadbolt locking mechanism

Item #	Finish	Pack
CHLL60X60-CH	Chrome	1 Pc./Box
CHLL60X60-BN	Brushed Nickel	1 Pc./Box
CHLL60X60-MBL	Matte Black	1 Pc./Box



24" Ladder Pull Back-to-Back Handle

- CHLP24X24 For 18" CTC hole spacing
- CHLP24X24-NEW For 12" CTC hole spacing
- 24" Total length
- For 5/16" to 1/2" (8 to 12 mm) glass

Item #	Finish	Pack
CHLP24X24-CH	Chrome	1 Pc./Box
CHLP24X24-BN	Brushed Nickel	1 Pc./Box
CHLP24X24-MBL	Matte Black	1 Pc./Box
CHLP24X24-NEW-CH	Chrome	1 Pc./Box
CHLP24X24-NEW-BN	Brushed Nickel	1 Pc./Box
CHLP24X24-NEW-MBL	Matte Black	1 Pc./Box



36" Ladder Pull Back-to-Back Handle

- 24" CTC hole spacing, 36" total length
- For 5/16" to 1/2" (8 to 12 mm) glass

Item #	Finish	Pack
CHLP36X36-CH	Chrome	1 Pc./Box
CHLP36X36-BN	Brushed Nickel	1 Pc./Box
CHLP36X36-MBL	Matte Black	1 Pc./Box



48" Ladder Pull Back-to-Back Handle

- 36" CTC hole spacing, 48" total length

Item #	Finish	Pack
CHLP48X48-CH	Chrome	1 Pc./Box
CHLP48X48-BN	Brushed Nickel	1 Pc./Box
CHLP48X48-MBL	Matte Black	1 Pc./Box



60" Ladder Pull Back-to-Back Handle

- 48" CTC hole spacing, 60" total length

Item #	Finish	Pack
CHLP60X60-CH	Chrome	1 Pc./Box
CHLP60X60-BN	Brushed Nickel	1 Pc./Box
CHLP60X60-MBL	Matte Black	1 Pc./Box



72" Ladder Pull Back-to-Back Handle

- 60" CTC hole spacing, 72" total length

Item #	Finish	Pack
CHLP72X72-CH	Chrome	1 Pc./Box
CHLP72X72-BN	Brushed Nickel	1 Pc./Box
CHLP72X72-MBL	Matte Black	1 Pc./Box



12" Glass Mounted Standard Pull Handle

- For 3/8" to 3/4" (10 to 19 mm) glass

Item #	Finish	Pack
CHCM12X12-CH	Chrome	1 Pc./Box
CHCM12X12-BN	Brushed Nickel	1 Pc./Box
CHCM12X12-MBL	Matte Black	1 Pc./Box



Thin Rectangular Cross-Section 48" Ladder Pull Back-to-Back Handle

- 36" CTC hole spacing, 48" total length

Item #	Finish	Pack
CHLP48X48-02-BN	Brushed Nickel	1 Pc./Box
CHLP48X48-02-MBL	Matte Black	1 Pc./Box



Semicircular Arc 60" Ladder Pull

- 60" total length

Item #	Finish	Pack
CHLP60X60-02-BN	Brushed Nickel	1 Pc./Box
CHLP60X60-02-MBL	Matte Black	1 Pc./Box



Magnetic Lock

- For 5/16"-3/8" thick glass
- Spring force adjustable
- DIN Left to Right side is changeable

Item #	Finish	Pack
LL-20MG-MBK	Anodized Mat Black	1 Pc./Box
LL-20MG-MS	Anodized Mat Silver	1 Pc./Box

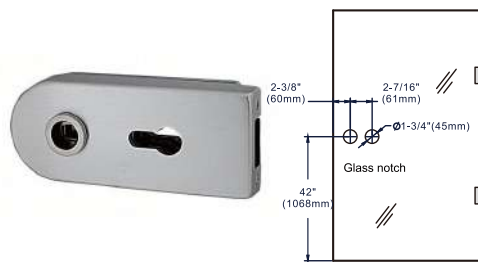

Europrofile Cylinder

- Pre-configured for magnetic lock installation
- Key on one side and thumbturn on the other side

Item #	Finish	Pack
9125ST-BK	Black Cover	1 Pc./Box
9125ST-SC	Satin Chrome	1 Pc./Box



Lever Handle

- Material: Drop-Forged Aluminium Alloy
- With 5/16" square spindle for all lever locks

Item #	Finish	Pack
LLD-207-MBK	Anodized Mat Black	1 Pc./Box
LLD-207-MS	Anodized Mat Silver	1 Pc./Box



Bottom Hydraulic Patch Fitting-hold Open

- For 3/8" or 1/2" (10 or 12 mm) glass

Item #	Finish	Pack
HGT-100-MBK	Anodized Mat Black	1 Pc./Box
HGT-100-PSS	Polished Stainless Steel	1 Pc./Box
HGT-100-SSS	Stainless Steel	1 Pc./Box



Adjustable Spring Power 90 Degree Hold Open Floor Mounted Closer

- Spring Power Adjustable
- UL Listed
- ANSI Grade 1 Listed
- 5 years limited warranty

Item #	Pack
CFDC150-ADJ	1 Pc./Box

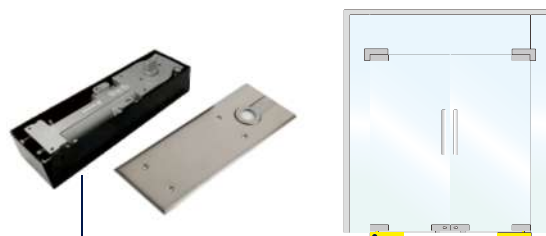

Heavy-Duty 90 Degree Hold Open Overhead Concealed Door Closer

- Maximum suitable for doors up to 1100mm wide.
- Threshold Mount Pivot
- 5 years limited warranty
- ANSI Listed

Item #	Pack
CTDCH120	1 Pc./Box

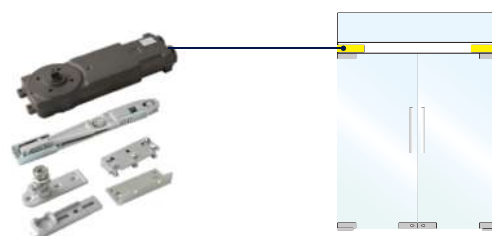

Commercial Door Patch Hardware

4"X36" Aluminum Double Door Header W/304ss Covers

- Includes Snap-In Cover Plates with All Door Closer Fabrication Completed
- Standard 4" Size
- Headers Do Not Include Door Closers

Item #	Finish	Pack
CSDH-4X36-BN	Brushed Nickel	1 Pc./Box
CSDH-4X36-MBL	Matte Black	1 Pc./Box
CSDH-4X36-SA	Satin Anodized	1 Pc./Box



4"X72" Aluminum Double Door Header W/304ss Covers

- Includes Snap-In Cover Plates with All Door Closer Fabrication Completed
- Standard 4" Size
- Headers Do Not Include Door Closers

Item #	Finish	Pack
CDDH-4X72-BN	Brushed Nickel	1 Pc./Box
CDDH-4X72-MBL	Matte Black	1 Pc./Box
CDDH-4X72-SA	Satin Anodized	1 Pc./Box



Top And Hydraulic Bottom Patch Fitting Set with Top Pivot and Base Plate

- For 3/8" or 1/2" (10 or 12 mm) glass
- 2-9/16" (65 mm) pivot setback
- 9/16" top & bottom gap

Item #	Finish	Pack
CHPF-CH	Chrome	1 Pc./Box
CHPF-BN	Brushed Nickel	1 Pc./Box
CHPF-MBL	Matte Black	1 Pc./Box



Commercial - Hydraulic Floor Hinge

- For 5/16"-1/2" glass
- Hold open at 90 degree up to 180 degree

Item #	Finish	Pack
CHFH-CH	Chrome	1 Pc./Box
CHFH-BN	Brushed Nickel	1 Pc./Box
CHFH-MBL	Matte Black	1 Pc./Box



Bottom Door Patch With 301 Insert

- For 3/8" or 1/2" (10 or 12 mm) tempered glass
- 2-3/4" (70 mm) pivot setback

Item #	Finish	Pack
CP10-301-CH	Chrome	1 Pc./Box
CP10-301-BN	Brushed Nickel	1 Pc./Box
CP10-301-MBL	Matte Black	1 Pc./Box
CP10-301-SA	Satin Anodized	1 Pc./Box

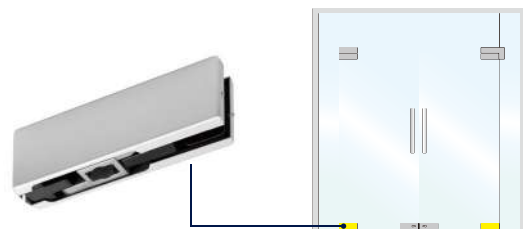

Top Door Patch With 303 Insert

- For 3/8" or 1/2" (10 or 12 mm) tempered glass
- 2-3/4" (70 mm) pivot setback

Item #	Finish	Pack
CP20-303-CH	Chrome	1 Pc./Box
CP20-303-BN	Brushed Nickel	1 Pc./Box
CP20-303-MBL	Matte Black	1 Pc./Box
CP20-303-SA	Satin Anodized	1 Pc./Box

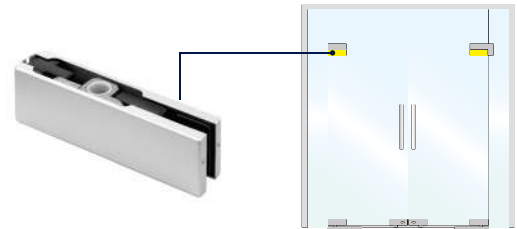

Top Door Patch With 304 Insert

- For 3/8" or 1/2" (10 or 12 mm) tempered glass
- For use with overhead concealed door closers

Item #	Finish	Pack
CP20-304-CH	Chrome	1 Pc./Box
CP20-304-BN	Brushed Nickel	1 Pc./Box
CP20-304-MBL	Matte Black	1 Pc./Box
CP20-304-SA	Satin Anodized	1 Pc./Box

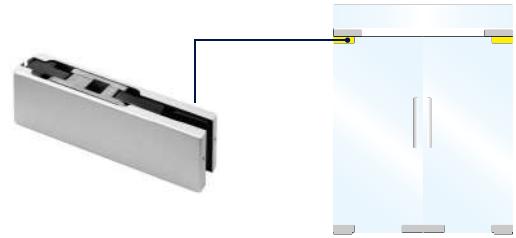

Wall Mounted Transom Patch With 300 Insert

- Works with both 2-3/4" and 2-9/16" (70 and 65 mm) pivot setback door patch fittings

Item #	Finish	Pack
CP34-300-CH	Chrome	1 Pc./Box
CP34-300-BN	Brushed Nickel	1 Pc./Box
CP34-300-MBL	Matte Black	1 Pc./Box
CP34-300-SA	Satin Anodized	1 Pc./Box

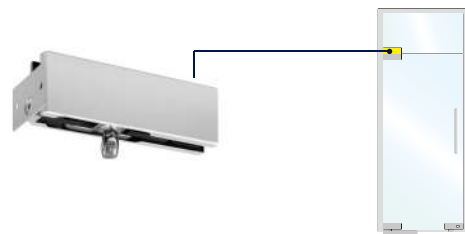

Sidelite Transom Patch With 300 Insert

- For 3/8" or 1/2" (10 or 12 mm) glass
- Works with both 2-3/4" and 2-9/16" (70 and 65 mm) pivot setback door patch fittings

Item #	Finish	Pack
CP40-300-CH	Chrome	1 Pc./Box
CP40-300-BN	Brushed Nickel	1 Pc./Box
CP40-300-MBL	Matte Black	1 Pc./Box
CP40-300-SA	Satin Anodized	1 Pc./Box

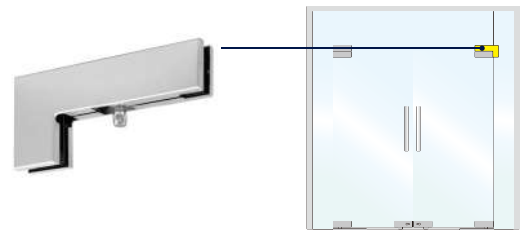

Sidelite Mounted Transom Patch with Reversible Door Stop

- For 3/8" or 1/2" (10 or 12 mm) tempered glass
- Free swing in/out application

Item #	Finish	Pack
CP60-CH	Chrome	1 Pc./Box
CP60-BN	Brushed Nickel	1 Pc./Box
CP60-MBL	Matte Black	1 Pc./Box
CP60-SA	Satin Anodized	1 Pc./Box



Transom Mounted Connector With Two Reversible Door Stops

- For 3/8" or 1/2" (10 or 12 mm) tempered glass
- Free swing in/out application

Item #	Finish	Pack
CP70-CH	Chrome	1 Pc./Box
CP70-BN	Brushed Nickel	1 Pc./Box
CP70-MBL	Matte Black	1 Pc./Box
CP70-SA	Satin Anodized	1 Pc./Box

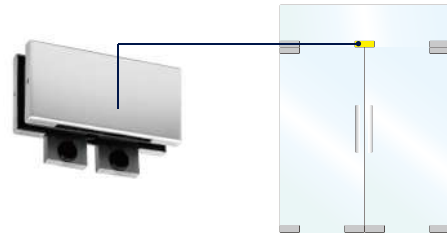

Transom Patch Glass Panel Connector

- For 3/8" or 1/2" (10 or 12 mm) tempered glass

Item #	Finish	Pack
CP80-CH	Chrome	1 Pc./Box
CP80-BN	Brushed Nickel	1 Pc./Box
CP80-MBL	Matte Black	1 Pc./Box
CP80-SA	Satin Anodized	1 Pc./Box

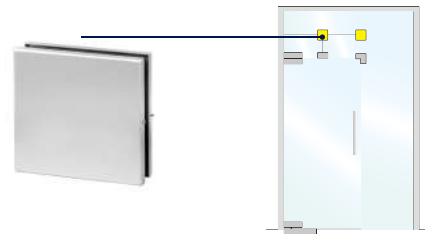

Bottom Patch Lock

- For 3/8" or 1/2" (10 or 12 mm) tempered glass

Item #	Finish	Pack
CP205-CH	Chrome	1 Pc./Box
CP205-BN	Brushed Nickel	1 Pc./Box
CP205-MBL	Matte Black	1 Pc./Box
CP205-SA	Satin Anodized	1 Pc./Box

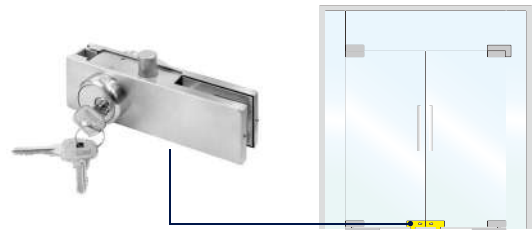

Top Center-Hung Free Swing Pivot

- Surface mount top pivot type for use with patch fittings

Item #	Finish	Pack
CP-401-BN	Brushed Nickel	1 Pc./Box
CP-401-MBL	Matte Black	1 Pc./Box

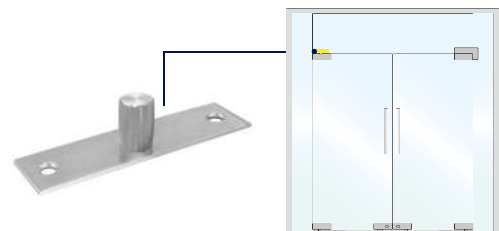

Adjustable Free-Swinging Bottom Pivot

- 3/16" (5 mm) of height adjustment
- Can be floor or threshold mounted

Item #	Finish	Pack
CP-403-BN	Brushed Nickel	1 Pc./Box
CP-403-MBL	Matte Black	1 Pc./Box
CP-403-SA	Satin Anodized	1 Pc./Box

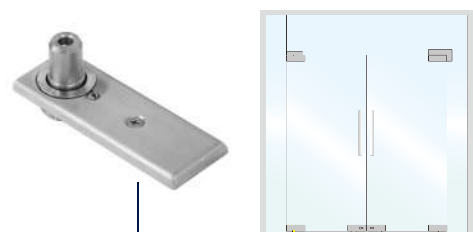

1/2" Glass 4" Square Door Rail Without Lock With Bottom Base Plate

- For 3/8-1/2" glass applications
- Standard 35-3/4" width for most applications

Item #	Finish	Pack
CDR4SB-CH	Chrome	1 Pc./Box
CDR4SB-BN	Brushed Nickel	1 Pc./Box
CDR4SB-MBL	Matte Black	1 Pc./Box
CDR4SB-SA	Satin Anodized	1 Pc./Box



1/2" Glass 4" Square Door Rail With Lock With Bottom Base Plate

- For 3/8-1/2" glass applications
- Standard 35-3/4" width for most applications

Item #	Finish	Pack
CDR4SBL-CH	Chrome	1 Pc./Box
CDR4SBL-BN	Brushed Nickel	1 Pc./Box
CDR4SBL-MBL	Matte Black	1 Pc./Box
CDR4SBL-SA	Satin Anodized	1 Pc./Box



1/2" Glass 4" Square Door Rail With Top Swing Pivot Left Hand From Interior View

- For 3/8-1/2" glass applications
- Standard 35-3/4" width for most applications

Item #	Finish	Pack
CDR4STL-CH	Chrome	1 Pc./Box
CDR4STL-BN	Brushed Nickel	1 Pc./Box
CDR4STL-MBL	Matte Black	1 Pc./Box
CDR4STL-SA	Satin Anodized	1 Pc./Box



1/2" Glass 4" Square Door Rail With Top Swing Pivot Right Hand From Interior View

- For 3/8-1/2" glass applications
- Standard 35-3/4" width for most applications

Item #	Finish	Pack
CDR4STR-CH	Chrome	1 Pc./Box
CDR4STR-BN	Brushed Nickel	1 Pc./Box
CDR4STR-MBL	Matte Black	1 Pc./Box
CDR4STR-SA	Satin Anodized	1 Pc./Box



Commercial Door Rail Keyed Cylinder

- Fits standard 4" door rails
- Can combine with thumbturn dummy cylinders

Item #	Finish	Pack
SDR4SBC-CH	Chrome	1 Pc./Box
SDR4SBC-BN	Brushed Nickel	1 Pc./Box
SDR4SBC-MBL	Matte Black	1 Pc./Box



Commercial Door Rail Thumbturn

- Fits standard 4" door rails
- Can combine with keyed or dummy cylinders

Item #	Finish	Pack
SDR4SBT-CH	Chrome	1 Pc./Box
SDR4SBT-BN	Brushed Nickel	1 Pc./Box
SDR4SBT-MBL	Matte Black	1 Pc./Box







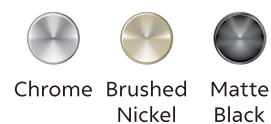

Commercial Door Hardware Sets

Office Partition Sliding Door System - OSD01

- Door width: 37 13/16" to 53 9/16"
- Door height: 98 7/16"
- Max. weight: 220lb.
- Available in chrome, brush nickel and matte black



OSD01	Description	Quantity
	84" or 106" Tube	1
	Anti-lift top roller with flush and surface mount fitting	2
	Glass mount clamp	2
	Door stopper	2
	Floor guide	1
	Pull handle	1
	End cap	2

Office Partition Sliding Door System - CLOSD

- Anti-Lift top roller system

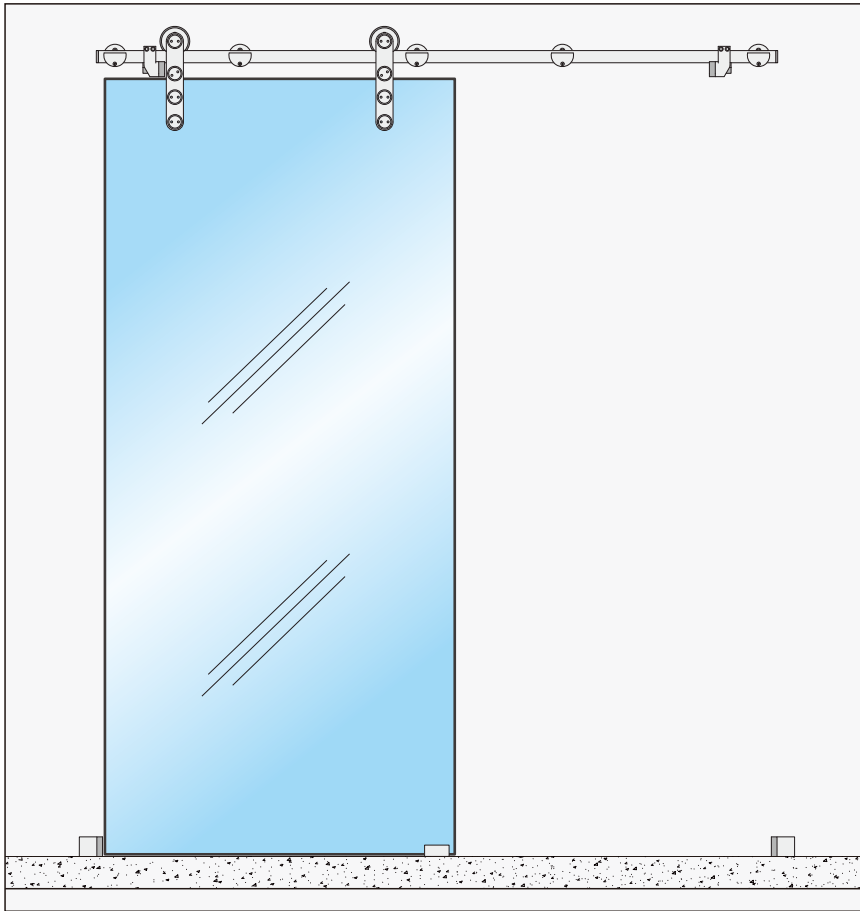

CLOSD	Description	Quantity
	Anti-Lift Top Roller	2
	Top Sliding Tube Glass Mount Clamp	5
	Left Hand Door Stop For Top Tube	1
	Right Hand Door Stop For Top Tube	1
	Adjustable Bottom Floor Guide	1
	End Cap For Dia25x2.5mm tube	2
	Tube Dia25xT2.0mm Length: 104" (2640mm)	1

Double Sliding Shower Door - UKD01 (Royal)

• Fits 48" - 72" opening

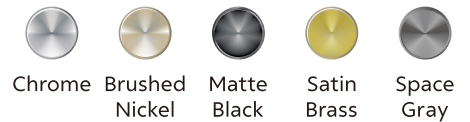

UKD01		Description	Quantity
UKD01HB		Header bar - Length: 48" - 98"	1
THLD-UKD01		Track holder	2
WMB-UKD01		Wall mount bracket	2
DRC01		Rubber cushion	4
ROL-UKD01		Roller - Diameter: 60mm	4
TBS20-D01		20" Towel bar - With alternative thru-glass pull	1
FNP01		Pull handle	1
AJN-UKD01		Anti-jump nail	4
BG-UKD01		Bottom guide - Length: 3"	1
TH-L		Threshold	1
PSET-DS		Glass-To-Wall Sealing Strip	4
RPB-UKD01		Return panel bracket	1

Single Sliding Shower Door - UKS04 (King)

• Fits 48" - 72" opening

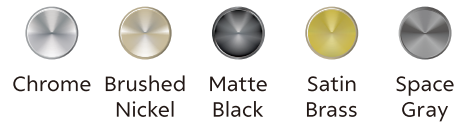

UKS04		Description	Quantity
UKS04HB		Tubular header bar - Length: 48" - 120"	1
WMB-UKS04		Wall mount bracket	2
FPB-UKS04		Fixed panel bracket	2
DRC01		Rubber cushion	2
ROL-UKS04		Roller - diameter: 70mm	4
HLP12-UKS04		12" Ladder style pull handle	1
BG-UKS04/05		Bottom guide - Length: 2-3/4"	1
TH-L		Threshold	1
PSET-DS		Glass-To-Wall Sealing Strip	2
PFIN-84		90° FIN SEAL	1
GCS4		Square wall clamp	1
RPB-UKS04/05		Return panel bracket	1

Single Sliding Shower Door - UKS03 (Prince)

• Fits 48" - 72" opening

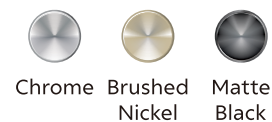

UKS03		Description	Quantity
UKS04HB		Header bar - Length: 48" - 120"	1
WMB-UKS04		Wall mount bracket	2
FPB-UKS04		Fixed panel bracket	2
DRC01		Rubber cushion	2
AJN-UKS05		Anti-jump nail	2
ROL-UKS04		Roller - diameter: 70mm	2
HLP12-UKS04		12" Ladder style pull handle	1
BG-UKS04/05		Bottom guide - Length: 2-3/4"	1
TH-L		Threshold	1
PSET-DS		Glass-to-Wall Sealing Strip	2
PFIN-84		90° FIN SEAL	1
GCS4		Square wall clamp	1
RPB-UKS04/05		Return panel bracket	1

Single Sliding Shower Door - UKS05 (Queen)

• Fits 48" - 72" opening

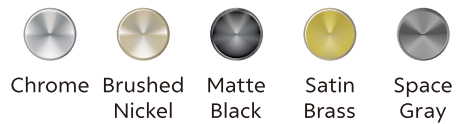







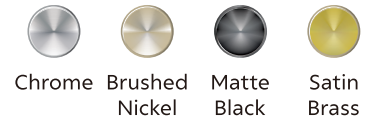

UKS05		Description	Quantity
UKS05HB		Square Header bar - Length: 48" - 120"	1
WMB-UKS05		Wall mount bracket	2
FPB-UKS05		Fixed panel bracket	2
DRC01		Rubber cushion	2
ROL-UKS05		Roller - Diameter: 70mm	2
HSQ8X8		8" Pull handle	1
BG-UKS04/05		Bottom guide - Length: 2-3/4"	1
AJN-UKS05		Anti-jump nails	2
TH-L		Threshold	1
PSET-DS		Glass-To-Wall Sealing Strip	2
PFIN-84		90° FIN SEAL	1
GCS4		Square wall clamp	1
RPB-UKS04/05		Return panel bracket	1

Double Sliding Shower Door - UKD08 (Duke)

• Fits 60" opening





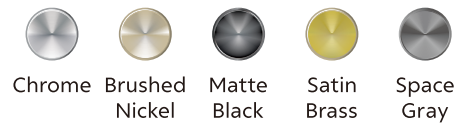

UKD08		Description	Quantity
UKD08HB		UKD08 Header Bar	1
SF-UKD08		Side Frame	2
BF-UKD08		Bottom Frame	1
ROL-UKD08		Roller For UKD08	4
PC-UKD08		Plastic Cushion For UKD08	6
BG-UKD08		UKD08 Track Holder	1
HTB20UKD08		20" Towel Bar For UKD08	1
KNB005S		Single Sided Cone Style Knob	1

Double Sliding Shower Door - UKD06 (Duchess)

- Fits 60" opening









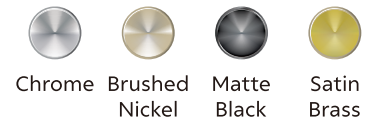





UKD06		Description	Quantity
UKD06HB		UKD06 Header Bar	1
SF-UKD06		Side Frame	2
BF-UKD06		Bottom Frame	1
ROL-UKD06		Wheels	4
CB-UKD06		Cushion Blocks (L & R)	4
PC-UKD06		Plastic Cushion for UKD06	4
BG-UKD06		Bottom Track Holder	1
SG-UKD06		Side Track Holder	2
HTB20UKD06		20" Towel Bar For UKD06	1
KNB006S		Finger Pull for UKD06	1

Single Sliding Shower Door - UKS09 (Princess)

- Fits 60" opening









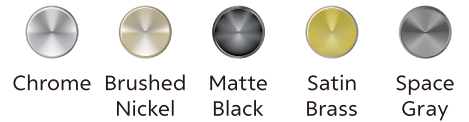



UKS09		Description	Quantity
UKS09HB		Square Header Bar - Length: 48" - 72"	1
WMB-UKS09		Wall Mount Bracket	2
ROL-UKS09		Roller - Diameter: 40mm	2
DSP-UKS09		Door Stopper	2
FPB-UKS09		Fixed Panel Bracket	2
AJN-UKS09		Anti-jump Nails	2
BG-UKS09		Bottom Guide - Length: 2-5/16"	1
FNP01		Pull Handle	1
TH-L		Threshold	1
PSET-DS		Glass-To-Wall Sealing Strip	2
PFIN-84		90° FIN SEAL	1
GCS4		Square Wall Clamp	1

Double Sliding Shower Door - UKD12 (Diplomat)

- Fits 60" opening









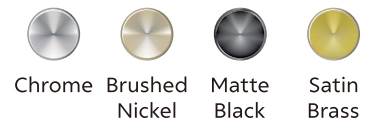



UKD12		Description	Quantity
UKD12HB		UKD12 Header Bar	1
SF-UKD12		Side Frame	2
BF-UKD12		Bottom Frame	1
ROL-UKD12		Wheels	4
SR-UKD12		Snap-in Retainer (Optional)	4
PC-UKD12		Plastic Cushion for UKD12	2
BG-UKD12		Bottom Track Holder for UKD12	1
SG-UKD12		Side Track Holder for UKD12	1
HTB24UKD12		24" Towel Bar for UKD12	1
KNB006S		Finger Pull for UKD12	1

Double Sliding Shower Door - UKD07N

- Fits 60" opening



UKD07N		Description	Quantity
UKD07HB		UKD07N Header Bar	1
SF-UKD07N		Side Frame	2
BF-UKD07N		Bottom Frame	1
ROL-UKD07N		Wheels	4
SR-UKD07N		Snap-in Retainer (Optional)	4
PC-UKD07N		Plastic Cushion for UKD07N	2
BG-UKD07N		Bottom Track Holder for UKD07N	1
SG-UKD07N		Side Track Holder for UKD07N	1
HTB24UKD07N		24" Towel bar For UKD07N	1
KNB006S		Finger Pull for UKD07N	1





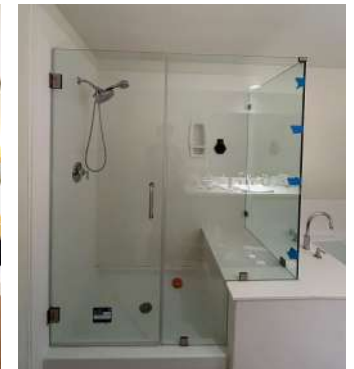



P-S&W-3/8-96 / P-S&W-1/2-96

Swing Door Bottom Wipe or Vertical Seal for Bi-Fold Door - 96"

- P-S&W-3/8-96 For 3/8" Glass
- P-S&W-1/2-96 For 1/2" Glass
- Length: 96" (hinge side)



PDJ-180-3/8-96 / PDJ-180-1/2-96

Swing Door 180° Inline Door-To-Fixed Panel Door Strike Jamb w/Seal - 96"

- PDJ-180-3/8-96 For 3/8" Glass
- PDJ-180-1/2-96 For 1/2" Glass



PBW-DR-32 / PBW-DR-3/8-96 / PBW-DR-1/2-96

Swing Door Bottom Wipe w/ 45° Drip Rail & 2 Vinyl Sweeps

- PBW-DR-32 / PBW-DR-3/8-96 For 3/8" Glass
- PBW-DR-1/2-96 For 1/2" Glass
- Available in 32" / 96"



P-INOUT-96

Swing Door Snap On Translucent Vinyl Bulb Seal for Both Hinge & Strike Jamb - 96"

- For 3/8" Glass
- Can be used on in-swing or out-swing doors



PDJ-L-84

Swing Door Multi-Purpose "L" Angle Jamb Seal for Both Hinge & Strike Jamb - 84"

- For 1/4" to 1/2" (6 to 12 mm) glass



PSET-H07

Swing Door Combo Set

- Available in 76" / 80"



PSET-DS

Sliding Door Combo Set - 2 Glass-To-Wall Sealing Strips

- For UKD01
- Length: 76" / 84"



PSET-SS

Single Sliding Door Combo Set - 2 Glass-To-Wall Sealing Strips and 1 Gap Fin-Seal

- For UKS03/04/05
- Available in 76" / 84"



PBW-Y-96

Bottom Rail With Wipe (CO-P500BR)

- Length: 96"



PFIN-84

Single Sliding Door 90° Vinyl Fin-Seal - 84"

- For model UKS04/05/09
- For gap between door and fixed panel



PDJ-90-96

Swing Door 90° Door-To-Fixed Panel Door Strike Jamb Seal

- "U" seal Polycarbonate strike and leg with 90 degree vinyl insert for 3/8" Glass
- Available in 96"



PDJ-MG-84

Swing Door 180° Inline Glass-To-Glass Magnetic Profile Seal - 84"

- For 3/8" to 1/2" (10 to 12 mm) glass



PDJ-135-96

Swing Door 135° Door-To-Fixed Panel Door Strike Jamb Seal - 96"

- For 3/8" Glass
- Length: 96" (glass to glass)



PBLB-84

Translucent Vinyl Bulb Seal

- For 3/8" Glass
- Length: 84"



PTWIPE

Swing Door T Wipe for 7/16" Max. Gap

- Length: 96"



TH-A-36

Acrylic Threshold - 36"

- Clear acrylic threshold
- 1/2" x 1/4" x 36"



PDJ-90/180-MG-3/8-80

180 Degree Magnetic Door Strike Jamb Seal for 3/8" Glass (2PCS/BAG)

- For 3/8" Glass

Standard Hinges

Wall Mount H-Plate Standard Hinge

- Wall mount full back plate standard hinge
- 3/8" (10mm) to 1/2" (12mm) glass

Item #	Finish	Pack
GIN037-CH	Chrome	1 Pc./Box
GIN037-BN	Brushed Nickel	1 Pc./Box
GIN037-MBL	Matte Black	1 Pc./Box
GIN037-SB	Satin Brass	1 Pc./Box
GIN037-GP	Gold Polished	1 Pc./Box
GIN037-SG	Space Gray	1 Pc./Box
GIN037-PC	Polished Copper	1 Pc./Box
GIN037-ABC	Antique Brush Copper	1 Pc./Box
GIN037-BBRZ	Brushed Bronze	1 Pc./Box
GIN037-PN	Polished Nickel	1 Pc./Box



Wall Mount Short H-Plate Standard Hinge

- Standard wall mount short back plate hinge
- 3/8" (10mm) to 1/2" (12mm) glass

Item #	Finish	Pack
GIN074-CH	Chrome	1 Pc./Box
GIN074-BN	Brushed Nickel	1 Pc./Box
GIN074-MBL	Matte Black	1 Pc./Box
GIN074-SB	Satin Brass	1 Pc./Box
GIN074-SG	Space Gray	1 Pc./Box
GIN074-BBRZ	Brushed Bronze	1 Pc./Box



Adjustable Wall Mount H-Plate Hinge

- Adjustable wall mount full back plate hinge
- Adjustable to any angle up to 90 degree without removing door
- 3/8" (10mm) to 1/2" (12mm) glass

Item #	Finish	Pack
GIN337-CH	Chrome	1 Pc./Box
GIN337-BN	Brushed Nickel	1 Pc./Box
GIN337-MBL	Matte Black	1 Pc./Box
GIN337-SB	Satin Brass	1 Pc./Box
GIN337-BBRZ	Brushed Bronze	1 Pc./Box

ADJUSTABLE



Wall Mount H-Plate Standard Hinge - 5 Degree Offset

- Self-Centering with reversible 5 degree pivot pin
- 3/8" (10mm) to 1/2" (12mm) glass

Item #	Finish	Pack
GIN537-CH	Chrome	1 Pc./Box
GIN537-BN	Brushed Nickel	1 Pc./Box
GIN537-MBL	Matte Black	1 Pc./Box
GIN537-SB	Satin Brass	1 Pc./Box
GIN537-GP	Gold Polished	1 Pc./Box



Wall Mount Short H-Plate Standard Hinge - 5 Degree Offset

- Short backplate shower hinge with black rubber gaskets with 5 degree offset
- 3/8" (10mm) to 1/2" (12mm) glass

Item #	Finish	Pack
GIN574-CH	Chrome	1 Pc./Box
GIN574-BN	Brushed Nickel	1 Pc./Box
GIN574-MBL	Matte Black	1 Pc./Box



Wall Mount Offset Standard Hinge

- Shower hinge with offset plate and rubber gaskets
- 3/8" (10mm) to 1/2" (12mm) glass

Item #	Finish	Pack
GIN044-CH	Chrome	1 Pc./Box
GIN044-BN	Brushed Nickel	1 Pc./Box
GIN044-MBL	Matte Black	1 Pc./Box
GIN044-BBRZ	Brushed Bronze	1 Pc./Box



90 Degree Glass to Glass Standard Hinge

- 90 degree glass-to-glass standard hinge
- 3/8" (10mm) to 1/2" (12mm) glass

Item #	Finish	Pack
GIN092-CH	Chrome	1 Pc./Box
GIN092-BN	Brushed Nickel	1 Pc./Box
GIN092-MBL	Matte Black	1 Pc./Box
GIN092-SB	Satin Brass	1 Pc./Box



Beveled Wall Mount H-Plate Hinge

- Wall mount full back H shape plate standard hinge
- 3/8" (10mm) to 1/2" (12mm) glass

Item #	Finish	Pack
PIC037-CH	Chrome	1 Pc./Box
PIC037-BN	Brushed Nickel	1 Pc./Box
PIC037-MBL	Matte Black	1 Pc./Box
PIC037-SB	Satin Brass	1 Pc./Box
PIC037-SG	Space Gray	1 Pc./Box
PIC037-BBRZ	Brushed Bronze	1 Pc./Box



Beveled Wall Mount Short H-Plate Hinge

- Wall mount short back H shape plate standard hinge
- 3/8" (10mm) to 1/2" (12mm) glass

Item #	Finish	Pack
PIC074-CH	Chrome	1 Pc./Box
PIC074-BN	Brushed Nickel	1 Pc./Box
PIC074-MBL	Matte Black	1 Pc./Box



Standard Hinges

Beveled Wall Mount H-Plate Hinge - 5 Degree Offset

- Self-Centering with reversible 5 degree pivot pin
- 3/8" (10mm) to 1/2" (12mm) glass

Item #	Finish	Pack
PIC537-CH	Chrome	1 Pc./Box
PIC537-BN	Brushed Nickel	1 Pc./Box
PIC537-MBL	Matte Black	1 Pc./Box
PIC537-SB	Satin Brass	1 Pc./Box



135 Degree Glass to Glass Standard Hinge

- 135 degree glass-to-glass standard hinge with black rubber gaskets
- 3/8" (10mm) to 1/2" (12mm) glass

Item #	Finish	Pack
GIN045-CH	Chrome	1 Pc./Box
GIN045-BN	Brushed Nickel	1 Pc./Box
GIN045-MBL	Matte Black	1 Pc./Box
GIN045-SB	Satin Brass	1 Pc./Box
GIN045-SG	Space Gray	1 Pc./Box



Adjustable 135 Degree Glass to Glass Standard Hinge

- Adjustable 135 degree glass-to-glass standard hinge
- 3/8" (10mm) to 1/2" (12mm) glass

Item #	Finish	Pack
GIN345-CH	Chrome	1 Pc./Box
GIN345-BN	Brushed Nickel	1 Pc./Box
GIN345-MBL	Matte Black	1 Pc./Box
GIN345-SB	Satin Brass	1 Pc./Box
GIN345-SG	Space Gray	1 Pc./Box



180 Degree Glass to Glass Standard Hinge

- 180 degree glass-to-glass standard hinge
- 3/8" (10mm) to 1/2" (12mm) glass

Item #	Finish	Pack
GIN180-CH	Chrome	1 Pc./Box
GIN180-BN	Brushed Nickel	1 Pc./Box
GIN180-MBL	Matte Black	1 Pc./Box
GIN180-SB	Satin Brass	1 Pc./Box
GIN180-SG	Space Gray	1 Pc./Box
GIN180-BBRZ	Brushed Bronze	1 Pc./Box
GIN180-PN	Polished Nickel	1 Pc./Box



Adjustable 180 Degree Glass to Glass Standard Hinge

- Adjustable 180 degree glass to glass standard hinge
- 3/8" (10mm) to 1/2" (12mm) glass

Item #	Finish	Pack
GIN380-CH	Chrome	1 Pc.
GIN380-BN	Brushed Nickel	1 Pc.
GIN380-MBL	Matte Black	1 Pc.
GIN380-SB	Satin Brass	1 Pc.



Beveled 180 Degree Glass to Glass Standard Hinge

- 180 degree glass-to-glass standard hinge
- 3/8" (10mm) to 1/2" (12mm) glass

Item #	Finish	Pack
PIC180-CH	Chrome	1 Pc./Box
PIC180-BN	Brushed Nickel	1 Pc./Box
PIC180-MBL	Matte Black	1 Pc./Box
PIC180-BBRZ	Brushed Bronze	1 Pc./Box



Lever Hinge With Reversed Mounting Plate

- 5/16" (8mm) to 3/8" (10mm) glass

Item #	Finish	Pack
LH-86RV-MBK	Anodized Mat Black	2 Pc./Box
LH-86RV-PSS	Polished Stainless Steel	2 Pc./Box
LH-86RV-PSS	Stainless Steel	2 Pc./Box

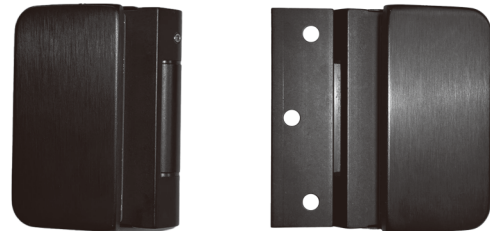

Lever Hinge

- 5/16" (8mm) to 3/8" (10mm) glass

Item #	Finish	Pack
LH-86-MBK	Anodized Mat Black	1 Pc./Box
LH-86-MS	Anodized Mat Silver	1 Pc./Box



Lever Hinge

- 90°/180° Glass to Glass
- 5/16" (8mm) to 3/8" (10mm) glass

Item #	Finish	Pack
LH-86.2/4-MBK	Anodized Mat Black	1 Pc./Box
LH-86.2/4-PSS	Polished Stainless Steel	1 Pc./Box
LH-86.2/4-SSS	Stainless Steel	1 Pc./Box

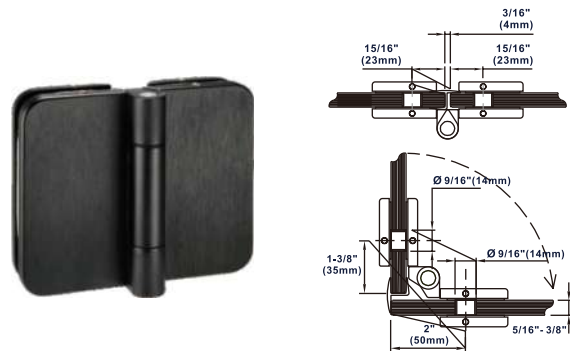

Heavy Duty Square 5 Degree Adjustable Wall Mount H Plate 90 Degree

- Heavy duty wall mount H plate 90 Degree - 5 degree adjustable
- 3/8" (10mm) to 1/2" (12mm) glass

Item #	Finish	Pack
VAN537-CH	Chrome	1 Pc./Box
VAN537-BN	Brushed Nickel	1 Pc./Box
VAN537-MBL	Matte Black	1 Pc./Box
VAN537-SB	Satin Brass	1 Pc./Box



Top or Bottom Mount Pivot Hinge

- 5/16" (8mm) to 3/8" (10mm) glass

Item #	Finish	Pack
PLK01-CH	Chrome	1 Pc./Box
PLK01-BN	Brushed Nickel	1 Pc./Box
PLK01-MBL	Matte Black	1 Pc./Box
PLK01-SB	Satin Brass	1 Pc./Box
PLK01-SG	Space Gray	1 Pc./Box



Square Top or Bottom Mount Pivot Hinge

- Floor ceiling / floor to header
- self centering
- 5/16" (8mm) to 3/8" (10mm) glass

Item #	Finish	Pack
PLK01S-CH	Chrome	1 Pc./Box
PLK01S-BN	Brushed Nickel	1 Pc./Box
PLK01S-MBL	Matte Black	1 Pc./Box
PLK01S-SB	Satin Brass	1 Pc./Box

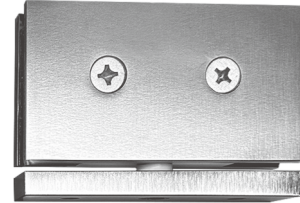

Glass-to-Glass Mount Pivot Hinge

- Glass to fixed transom mount
- most weight hinge carried at the bottom
- 5/16" (8mm) to 3/8" (10mm) glass

Item #	Finish	Pack
PLK03-CH	Chrome	1 Pc./Box
PLK03-BN	Brushed Nickel	1 Pc./Box
PLK03-MBL	Matte Black	1 Pc./Box
PLK03-SB	Satin Brass	1 Pc./Box



Square Glass-to-Glass Mount Pivot Hinge

- Ability to inset from the wall to provide clearance for any projections
- Less cutout requires than 180° hinges
- 5/16" (8mm) to 3/8" (10mm) glass

Item #	Finish	Pack
PLK03S-CH	Chrome	1 Pc./Box
PLK03S-BN	Brushed Nickel	1 Pc./Box
PLK03S-MBL	Matte Black	1 Pc./Box
PLK03S-SB	Satin Brass	1 Pc./Box



Top or Bottom Mount Pivot Hinge with Attached U-Clamp

- Attached U-clamp has same design and profile as hinge
- Top / bottom install
- Self centering within 15° of closed positioning
- 5/16" (8mm) to 3/8" (10mm) glass

Item #	Finish	Pack
PLK07-CH	Chrome	1 Pc./Box
PLK07-BN	Brushed Nickel	1 Pc./Box
PLK07-MBL	Matte Black	1 Pc./Box
PLK07-SB	Satin Brass	1 Pc./Box



Square Top or Bottom Mount Pivot Hinge with Attached U-Clamp

- Less cutouts compared to GEN180 application
- 5/16" (8mm) to 3/8" (10mm) glass

Item #	Finish	Pack
PLK07S-CH	Chrome	1 Pc./Box
PLK07S-BN	Brushed Nickel	1 Pc./Box
PLK07S-MBL	Matte Black	1 Pc./Box
PLK07S-SB	Satin Brass	1 Pc./Box



Heavy Duty Wall Mount H-Plate Hinge

- Heavy duty wall mount full back standard hinge
- 3/8" (10mm) to 1/2" (12mm) glass

Item #	Finish	Pack
VAN037-CH	Chrome	1 Pc./Box
VAN037-BN	Brushed Nickel	1 Pc./Box
VAN037-MBL	Matte Black	1 Pc./Box
VAN037-SB	Satin Brass	1 Pc./Box
VAN037-SG	Space Gray	1 Pc./Box
VAN037-GP	Gold Polished	1 Pc./Box
VAN037-BBRZ	Brushed Bronze	1 Pc./Box
VAN037-PN	Polished Nickel	1 Pc./Box



Heavy Duty Short H-Plate Hinge

- Heavy duty wall mount short back plate standard hinge
- 3/8" (10mm) to 1/2" (12mm) glass

Item #	Finish	Pack
VAN074-CH	Chrome	1 Pc./Box
VAN074-BN	Brushed Nickel	1 Pc./Box
VAN074-MBL	Matte Black	1 Pc./Box
VAN074-SB	Satin Brass	1 Pc./Box
VAN074-BBRZ	Brushed Bronze	1 Pc./Box



Heavy Duty Adjustable H-Plate Hinge

- Heavy duty adjustable wall mount full back plate hinge, adjustable to any angle up to 90 degree without removing door
- 3/8" (10mm) to 1/2" (12mm) glass

Item #	Finish	Pack
VAN337-CH	Chrome	1 Pc./Box
VAN337-BN	Brushed Nickel	1 Pc./Box
VAN337-MBL	Matte Black	1 Pc./Box
VAN337-SB	Satin Brass	1 Pc./Box
VAN337-BBRZ	Brushed Bronze	1 Pc./Box



Heavy Duty Offset Short Back Plate Standard Hinge

- Heavy duty offset short back plate standard hinge
- 3/8" (10mm) to 1/2" (12mm) glass

Item #	Finish	Pack
VAN040-CH	Chrome	1 Pc./Box
VAN040-BN	Brushed Nickel	1 Pc./Box
VAN040-MBL	Matte Black	1 Pc./Box
VAN040-SB	Satin Brass	1 Pc./Box



Heavy Duty Hinge

Heavy Duty Offset 90 Degree Hinge

- Shower hinge with offset plate and black rubber gasket
- 3/8" (10mm) to 1/2" (12mm) glass

Item #	Finish	Pack
VAN044-CH	Chrome	1 Pc./Box
VAN044-BN	Brushed Nickel	1 Pc./Box
VAN044-MBL	Matte Black	1 Pc./Box
VAN044-SB	Satin Brass	1 Pc./Box
VAN044-BBRZ	Brushed Bronze	1 Pc./Box



Heavy Duty Square Glass To Glass 90 Degrees Hinge

- Heavy duty 90 degree glass-to-glass hinge
- 3/8" (10mm) to 1/2" (12mm) glass

Item #	Finish	Pack
VAN092-CH	Chrome	1 Pc./Box
VAN092-BN	Brushed Nickel	1 Pc./Box
VAN092-MBL	Matte Black	1 Pc./Box
VAN092-SB	Satin Brass	1 Pc./Box



Heavy Duty Wall Mount Beveled H-Plate Hinge

- Wall mount full back beveled heavy duty hinge with 5 degree offset
- 3/8" (10mm) to 1/2" (12mm) glass

Item #	Finish	Pack
CHA037-CH	Chrome	1 Pc./Box
CHA037-BN	Brushed Nickel	1 Pc./Box
CHA037-MBL	Matte Black	1 Pc./Box
CHA037-SB	Satin Brass	1 Pc./Box
CHA037-SG	Space Gray	1 Pc./Box



Heavy Duty Wall Mount Beveled H-Plate Hinge - 5 Degree Offset

- Wall mount full back beveled heavy duty hinge with 5 degree offset
- 3/8" (10mm) to 1/2" (12mm) glass

Item #	Finish	Pack
CHA537-CH	Chrome	1 Pc./Box
CHA537-BN	Brushed Nickel	1 Pc./Box
CHA537-MBL	Matte Black	1 Pc./Box



Heavy Duty 135 Degree Glass to Glass Hinge

- Heavy duty 135 degree glass-to-glass hinge
- 3/8" (10mm) to 1/2" (12mm) glass

Item #	Finish	Pack
VAN045-CH	Chrome	1 Pc./Box
VAN045-BN	Brushed Nickel	1 Pc./Box
VAN045-MBL	Matte Black	1 Pc./Box
VAN045-SB	Satin Brass	1 Pc./Box
VAN045-SG	Space Gray	1 Pc./Box



Heavy Duty Adjustable 135 Degree Hinge

- Heavy duty 135 degree glass-to-glass hinge with internal 5 degree pin
- 3/8" (10mm) to 1/2" (12mm) glass

Item #	Finish	Pack
VAN345-CH	Chrome	1 Pc./Box
VAN345-BN	Brushed Nickel	1 Pc./Box
VAN345-MBL	Matte Black	1 Pc./Box
VAN345-SB	Satin Brass	1 Pc./Box
VAN345-SG	Space Gray	1 Pc./Box

ADJUSTABLE



Heavy Duty Adjustable 135 Degree Beveled Hinge

- Heavy duty 135 degree glass-to-glass hinge with internal 5 degree pin
- 3/8" (10mm) to 1/2" (12mm) glass

Item #	Finish	Pack
CHA345-CH	Chrome	1 Pc./Box
CHA345-BN	Brushed Nickel	1 Pc./Box
CHA345-MBL	Matte Black	1 Pc./Box

ADJUSTABLE



Heavy Duty 180 Degree Glass to Glass Hinge

- Heavy duty 180 degree glass-to-glass Standard Hinge
- 3/8" (10mm) to 1/2" (12mm) glass

Item #	Finish	Pack
VAN180-CH	Chrome	1 Pc./Box
VAN180-BN	Brushed Nickel	1 Pc./Box
VAN180-MBL	Matte Black	1 Pc./Box
VAN180-SB	Satin Brass	1 Pc./Box
VAN180-SG	Space Gray	1 Pc./Box
VAN180-BBRZ	Brushed Bronze	1 Pc./Box
VAN180-PN	Polished Nickel	1 Pc./Box



Heavy Duty 180 Degree Glass to Glass Hinge

- Heavy duty 180 degree glass-to-glass Standard Hinge
- 3/8" (10mm) to 1/2" (12mm) glass

Item #	Finish	Pack
VAN380-CH	Chrome	1 Pc./Box
VAN380-BN	Brushed Nickel	1 Pc./Box
VAN380-MBL	Matte Black	1 Pc./Box
VAN380-SB	Satin Brass	1 Pc./Box

ADJUSTABLE

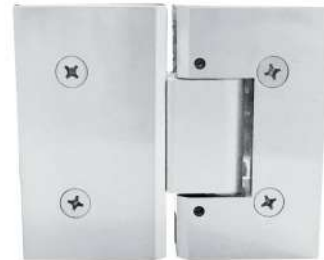

Heavy Duty 180 Degree Glass to Glass Hinge - 5 Degree Offset

- Glass-to-glass hinge with internal 5 degree pin
- 3/8" (10mm) to 1/2" (12mm) glass

Item #	Finish	Pack
VAN580-CH	Chrome	1 Pc./Box
VAN580-BN	Brushed Nickel	1 Pc./Box
VAN580-MBL	Matte Black	1 Pc./Box



Heavy Duty 180 Degree Glass-to-Glass Beveled Hinge

- Heavy Duty 180 Degree Glass-to-Glass Beveled Hinge
- 3/8" (10mm) to 1/2" (12mm) glass

Item #	Finish	Pack
CHA180-CH	Chrome	1 Pc./Box
CHA180-BN	Brushed Nickel	1 Pc./Box
CHA180-MBL	Matte Black	1 Pc./Box



Heavy Duty Top or Bottom Mount Pivot Hinge

- For use with 1/2" (12 mm) glass

Item #	Finish	Pack
PLKH02-CH	Chrome	1 Pc./Box
PLKH02-BN	Brushed Nickel	1 Pc./Box
PLKH02-MBL	Matte Black	1 Pc./Box
PLKH02-SB	Satin Brass	1 Pc./Box
PLKH02-SG	Space Gray	1 Pc./Box
PLKH02-BBRZ	Brushed Bronze	1 Pc./Box



Heavy Duty Square Top or Bottom Mount Pivot Hinge

- Must use grd-ct 03 to use header
- Floor and ceiling mounted
- 5/16" (8mm) to 1/2" (12mm) glass

Item #	Finish	Pack
PLKH02S-CH	Chrome	1 Pc./Box
PLKH02S-BN	Brushed Nickel	1 Pc./Box
PLKH02S-MBL	Matte Black	1 Pc./Box
PLKH02S-SB	Satin Brass	1 Pc./Box

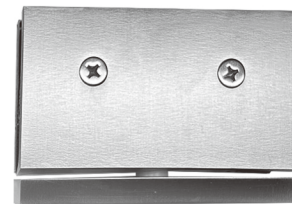

Heavy Duty Glass-to-Glass Mount Pivot Hinge

- Self centering at 15° closed position
- 5/16" (8mm) to 1/2" (12mm) glass

Item #	Finish	Pack
PLKH03-CH	Chrome	1 Pc./Box
PLKH03-BN	Brushed Nickel	1 Pc./Box
PLKH03-MBL	Matte Black	1 Pc./Box
PLKH03-SB	Satin Brass	1 Pc./Box



Square Hole-In-Glass Fixed Panel U-Clamp

- 3/8" (10mm) to 1/2" (12mm) glass
- 5/8" or 3/4" (16 or 19mm) hole in panel (51x51x4mm)

Item #	Finish	Pack
GCS4-CH	Chrome	1 Pc./Box
GCS4-BN	Brushed Nickel	1 Pc./Box
GCS4-MBL	Matte Black	1 Pc./Box
GCS4-SB	Satin Brass	1 Pc./Box
GCS4-SG	Space Gray	1 Pc./Box
GCS4-PC	Polished Copper	1 Pc./Box
GCS4-GP	Gold Plated	1 Pc./Box
GCS4-ABC	Antique Brush Copper	1 Pc./Box
GCS4-BBRZ	Brushed Bronze	1 Pc./Box
GCS4-PN	Polished Nickel	1 Pc./Box



Beveled Hole-In-Glass Fixed Panel U-Clamp

- 3/8" (10mm) to 1/2" (12mm) glass
- 5/8" or 3/4" (16 or 19mm) hole in panel (51x51x4mm)

Item #	Finish	Pack
GCR4-CH	Chrome	1 Pc./Box
GCR4-BN	Brushed Nickel	1 Pc./Box
GCR4-MBL	Matte Black	1 Pc./Box
GCR4-SB	Satin Brass	1 Pc./Box
GCR4-SG	Space Gray	1 Pc./Box
GCR4-BBRZ	Brushed Bronze	1 Pc./Box



90 Degree Wall Mount Glass Clamp

- For 5/16" to 1/2" (8 to 12mm) glass (42x42x4mm)

Item #	Finish	Pack
GCS039-CH	Chrome	1 Pc./Box
GCS039-BN	Brushed Nickel	1 Pc./Box
GCS039-MBL	Matte Black	1 Pc./Box
GCS039-SB	Satin Brass	1 Pc./Box



Square Wall Mount Movable Transom Clamp

- 3/8" (10mm) to 1/2" (12mm) glass
- Glass transom swivels to allow release of steam

Item #	Finish	Pack
GCS186-CH	Chrome	1 Pc./Box
GCS186-BN	Brushed Nickel	1 Pc./Box
GCS186-MBL	Matte Black	1 Pc./Box
GCS186-SB	Satin Brass	1 Pc./Box
GCS186-PN	Polished Nickel	1 Pc./Box



Square 180 Degree Glass-to-Glass Movable Transom Clamp

- 3/8" (10mm) to 1/2" (12mm) glass
- Glass transom swivels to allow release of steam

Item #	Finish	Pack
GCS188-CH	Chrome	1 Pc./Box
GCS188-BN	Brushed Nickel	1 Pc./Box
GCS188-MBL	Matte Black	1 Pc./Box
GCS188-SB	Satin Brass	1 Pc./Box
GCS188-PN	Polished Nickel	1 Pc./Box



180 Degree Glass to Glass Clamp

- For 5/16" to 1/2" (8 to 12mm) glass (42x42x4mm)
- 5/8" or 3/4" (16 or 19mm) hole in panel

Item #	Finish	Pack
GCS180-CH	Chrome	1 Pc./Box
GCS180-BN	Brushed Nickel	1 Pc./Box
GCS180-MBL	Matte Black	1 Pc./Box
GCS180-PN	Polished Nickel	1 Pc./Box



Glass Clamps

135 Degree Glass to Glass Clamp

- For 5/16" to 1/2" (8 to 12mm) glass (42x42x4mm)
- 5/8" or 3/4" (16 or 19mm) hole in panel

Item #	Finish	Pack
GCS135-CH	Chrome	1 Pc./Box
GCS135-BN	Brushed Nickel	1 Pc./Box
GCS135-MBL	Matte Black	1 Pc./Box
GCS135-SB	Satin Brass	1 Pc./Box



90 Degree Glass to Glass Clamp

- For 3/8" to 1/2" (10 to 12 mm)

Item #	Finish	Pack
GCS90TO90-CH	Chrome	1 Pc./Box
GCS90TO90-BN	Brushed Nickel	1 Pc./Box
GCS90TO90-MBL	Matte Black	1 Pc./Box
GCS90TO90-SB	Satin Brass	1 Pc./Box

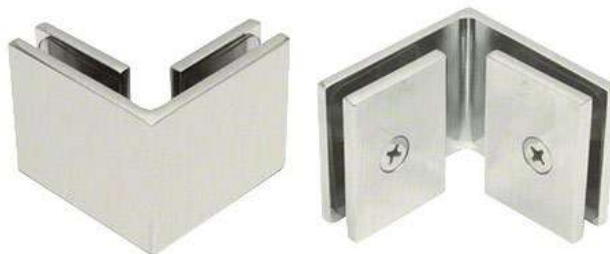

90 Degree Open Face Glass to Glass Clamp

- For 3/8" to 1/2" (10 to 12 mm)

Item #	Finish	Pack
GCSOF90-CH	Chrome	1 Pc./Box
GCSOF90-BN	Brushed Nickel	1 Pc./Box
GCSOF90-MBL	Matte Black	1 Pc./Box
GCSOF90-SB	Satin Brass	1 Pc./Box



Wall Mount Bracket

- For 5/16" to 1/2" (8 to 12mm) glass (42x42x4mm)

Item #	Finish	Pack
GCS90S-CH	Chrome	1 Pc./Box
GCS90S-BN	Brushed Nickel	1 Pc./Box
GCS90S-MBL	Matte Black	1 Pc./Box
GCS90S-SB	Satin Brass	1 Pc./Box
GCS90S-SG	Space Gray	1 Pc./Box



Beveled Wall Mount Bracket

- For 5/16" to 1/2" (8 to 12 mm) glass

Item #	Finish	Pack
GCR190-CH	Chrome	1 Pc./Box
GCR190-BN	Brushed Nickel	1 Pc./Box
GCR190-MBL	Matte Black	1 Pc./Box
GCR190-SB	Satin Brass	1 Pc./Box



Designed to secure fixed panel glass

- Requires glass fabrication
- For 3/8" to 1/2" (10 to 12 mm) thick tempered safety glass

Item #	Finish	Pack
GCRY182-CH	Chrome	1 Pc./Box
GCRY182-BN	Brushed Nickel	1 Pc./Box
GCRY182-MBL	Matte Black	1 Pc./Box
GCRY182-SB	Satin Brass	1 Pc./Box



Adjustable 90 Degree Wall Mount Glass Clamp

- For 5/16" to 1/2" (8 to 12 mm) glass (42x42x4mm)

Item #	Finish	Pack
GCR037ADJ-CH	Chrome	1 Pc./Box
GCR037ADJ-BN	Brushed Nickel	1 Pc./Box
GCR037ADJ-MBL	Matte Black	1 Pc./Box



Glass End Support

- Fits dia. 25mm tube

Item #	Finish	Pack
GES-UKS04-CH	Chrome	1 Pc./Box
GES-UKS04-BN	Brushed Nickel	1 Pc./Box
GES-UKS04-MBL	Matte Black	1 Pc./Box



Adjustable Beveled Hold-In-Glass Fixed Panel U-Clamp (CO-SCU4-ADJ)

- For 1/4" to 3/8" (6 to 10 mm) thick glass
- Maximum 5" (127 mm) glass protrusion from wall is recommended.
- 5/8" or 3/4" (16 or 19mm) hole in panel (51x51x4mm), no cut

Item #	Finish	Pack
GCS4NF-CH	Chrome	1 Pc./Box
GCS4NF-BN	Brushed Nickel	1 Pc./Box
GCS4NF-MBL	Matte Black	1 Pc./Box



Small Square Interior Shelf Clamp

- For 1/4" to 3/8" (6 to 10 mm) thick glass
- No glass fabrication required

Item #	Finish	Pack
GCS10-CH	Chrome	1 Pc./Box
GCS10-BN	Brushed Nickel	1 Pc./Box
GCS10-MBL	Matte Black	1 Pc./Box



18" Steel Shelf Bracket

- Maximum 23-5/8" (600 mm) glass protrusion from wall is recommended.

Item #	Finish	Pack
GCS18-MBL	Matte Black	2 Pcs./Box
GCS18-WT	White	2 Pcs./Box



Rectangular Interior Shower Shelf Clamp

- For 1/4" to 3/8" (6 to 10 mm) thick glass
- Maximum 5" (127 mm) glass protrusion from wall is recommended.

Item #	Finish	Pack
GCS11-CH	Chrome	1 Pc./Box
GCS11-BN	Brushed Nickel	1 Pc./Box
GCS11-MBL	Matte Black	1 Pc./Box

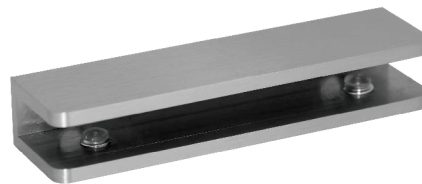

Round Shelf Clamp

- For 1/4" to 3/8" (6 to 10 mm) thick glass
- Maximum 5" (127 mm) glass protrusion from wall is recommended.

Item #	Finish	Pack
GCS12-CH	Chrome	1 Pc./Box
GCS12-BN	Brushed Nickel	1 Pc./Box
GCS12-MBL	Matte Black	1 Pc./Box



Heavy Duty Adjustable Shelf Clamp

- For 1/8" to 15/16" (3 to 24 mm) thick glass

Item #	Finish	Pack
GCS661-CH	Chrome	1 Pc./Box
GCS661-BN	Brushed Nickel	1 Pc./Box
GCS661-MBL	Matte Black	1 Pc./Box



Heavy Duty Zinc Alloy Adjustable Rectangular Shelf Clamp

- For 1/8" to 1-1/8" (3 to 28 mm) thick glass
- Maximum 7-7/8" (200 mm) glass protrusion from wall is recommended.

Item #	Finish	Pack
GCS163-CH	Chrome	1 Pc./Box
GCS163-BN	Brushed Nickel	1 Pc./Box
GCS163-MBL	Matte Black	1 Pc./Box



Sleeve Over Clamp - 90 Degree T Glass Clamp

- For 5/16" (8mm) to 1/2" (12mm) glass

Item #	Finish	Pack
SOC90T-CH	Chrome	1 Pc./Box
SOC90T-BN	Brushed Nickel	1 Pc./Box
SOC90T-MBL	Matte Black	1 Pc./Box
SOC90T-SB	Satin Brass	1 Pc./Box



90 Degree "Sleeve Over" Wall Mount Glass Clamp - Left

- For 5/16" to 1/2" (8 to 12mm) glass (42x42x4mm)

Item #	Finish	Pack
SOC37L-CH	Chrome	1 Pc./Box
SOC37L-BN	Brushed Nickel	1 Pc./Box
SOC37L-MBL	Matte Black	1 Pc./Box
SOC37L-SB	Satin Brass	1 Pc./Box
SOC37L-SG	Space Gray	1 Pc./Box
SOC37L-BBRZ	Brushed Bronze	1 Pc./Box



90 Degree "Sleeve Over" Wall Mount Glass Clamp - Right

- For 5/16" to 1/2" (8 to 12mm) glass (42x42x4mm)

Item #	Finish	Pack
SOC37R-CH	Chrome	1 Pc./Box
SOC37R-BN	Brushed Nickel	1 Pc./Box
SOC37R-MBL	Matte Black	1 Pc./Box
SOC37R-SB	Satin Brass	1 Pc./Box
SOC37R-SG	Space Gray	1 Pc./Box
SOC37R-BBRZ	Brushed Bronze	1 Pc./Box



90 Degree "Sleeve Over" Glass Clamp

- For 5/16" to 1/2" (8 to 12mm) glass (42x42x4mm)

Item #	Finish	Pack
SOC90-CH	Chrome	1 Pc./Box
SOC90-BN	Brushed Nickel	1 Pc./Box
SOC90-MBL	Matte Black	1 Pc./Box
SOC90-SB	Satin Brass	1 Pc./Box
SOC90-SG	Space Gray	1 Pc./Box
SOC90-GP	Gold Polish	1 Pc./Box
SOC90-PC	Polished Copper	1 Pc./Box
SOC90-ABC	Antique Brush Copper	1 Pc./Box
SOC90-BBRZ	Brushed Bronze	1 Pc./Box
SOC90-PN	Polished Nickel	1 Pc./Box



135 Degree "Sleeve Over" Glass Clamp

- For 5/16" to 1/2" (8 to 12mm) glass (42x42x4mm)

Item #	Finish	Pack
SOC135-CH	Chrome	1 Pc./Box
SOC135-BN	Brushed Nickel	1 Pc./Box
SOC135-MBL	Matte Black	1 Pc./Box
SOC135-SB	Satin Brass	1 Pc./Box



Adjustable 90 to 180 Degree "Sleeve Over" Clamp

- Adjustable from 90 to 180 degree
- For 5/16" to 1/2" (8 to 12mm) glass (42x42x4mm)

Item #	Finish	Pack
SOC90ADJ-CH	Chrome	1 Pc./Box
SOC90ADJ-BN	Brushed Nickel	1 Pc./Box
SOC90ADJ-MBL	Matte Black	1 Pc./Box
SOC90ADJ-SB	Satin Brass	1 Pc./Box

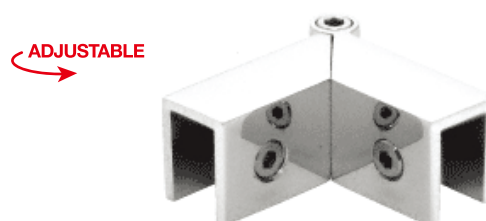

Shower Door Header Accessories

Grand Series Shower Door Header Hardware Kit

- Includes one 98" header bar, one 36" door pocket filler, one pair of wall mounting bracket, and one clear vinyl

Item #	Finish	Pack
GND-KD98-CH	Chrome	1 Pc./Box
GND-KD98-BN	Brushed Nickel	1 Pc./Box
GND-KD98-MBL	Matte Black	1 Pc./Box
GND-KD98-SB	Satin Brass	1 Pc./Box
GND-KD98-SG	Space Gray	1 Pc./Box
GND-KD98-GP	Gold Plated	1 Pc./Box



90 Degree Brass Adjustable Corner for the Grand Series Header Kit

- Connect and secure header pieces

Item #	Finish	Pack
GND-CT90ADJ	Brass	1 Pc./Box



135 Degree Brass Fixed Corner for the Grand Series Header Kit

- Connect and secure header pieces

Item #	Finish	Pack
GND-CT135	Brass	1 Pc./Box



Header Bar Bracket (Pair)

- Aluminum standard wall brackets
- Sold in pairs

Item #	Finish	Pack
GND-CT01	Brass	2 Pcs./Box



Bright Anodized Adapter Block

Item #	Finish	Pack
GND-CT02-CH	Chrome	1 Pc./Box
GND-CT02-BN	Brushed Nickel	1 Pc./Box
GND-CT02-MBL	Matte Black	1 Pc./Box
GND-CT02-SB	Satin Brass	1 Pc./Box



Adapter Block for PLKH02

Item #	Finish	Pack
GND-CT03-CH	Chrome	1 Pc./Box
GND-CT03-BN	Brushed Nickel	1 Pc./Box
GND-CT03-MBL	Matte Black	1 Pc./Box
GND-CT03-SB	Satin Brass	1 Pc./Box



UKD01 Header Bar

- Available in 48", 55", 60", 65", 72", 84", and 98"

Item #	Finish	Pack
UKD01HB-CH	Chrome	1 Pc.
UKD01HB-BN	Brushed Nickel	1 Pc.
UKD01HB-MBL	Matte Black	1 Pc.
UKD01HB-SB	Satin Brass	1 Pc.
UKD01HB-SG	Space Gray	1 Pc.



UKS04 Header Bar Without Hole

- Thickness: 3mm
- Available in 72", 84", 98", 106" and 120"

Item #	Finish	Pack
UKS04HB-HN-CH	Chrome	1 Pc.
UKS04HB-HN-BN	Brushed Nickel	1 Pc.
UKS04HB-HN-MBL	Matte Black	1 Pc.
UKS04HB-HN-SB	Satin Brass	1 Pc.
UKS04HB-HN-SG	Space Gray	1 Pc.



UKS04 Header Bar With Hole

- Thickness: 3mm
- Available in 48", 55", 60", 65", and 72"

Item #	Finish	Pack
UKS04HB-CH	Chrome	1 Pc.
UKS04HB-BN	Brushed Nickel	1 Pc.
UKS04HB-MBL	Matte Black	1 Pc.
UKS04HB-SB	Satin Brass	1 Pc.



UKS05 Header Bar Without Hole

- Thickness: 2.5mm
- Available in 72", 84", 98", 106" and 120"

Item #	Finish	Pack
UKS05HB-NH-CH	Chrome	1 Pc./Box
UKS05HB-NH-BN	Brushed Nickel	1 Pc./Box
UKS05HB-NH-MBL	Matte Black	1 Pc./Box
UKS05HB-NH-SB	Satin Brass	1 Pc./Box



UKS05 Header Bar With Hole

- Thickness: 2.5mm
- Available in 48", 55", 60", 65", and 72"

Item #	Finish	Pack
UKS05HB-CH	Chrome	1 Pc./Box
UKS05HB-BN	Brushed Nickel	1 Pc./Box
UKS05HB-MBL	Matte Black	1 Pc./Box



U-Channel - 1/2"

- For 1/2" Glass, 3/4" (19mm) high profile deep U channel
- Provides support to shower enclosures without touching the ceiling

Item #	Finish	Pack
UCN-1/2-98 -CH	Chrome	1 Pc.
UCN-1/2-98 -BN	Brushed Nickel	1 Pc.
UCN-1/2-98 -MBL	Matte Black	1 Pc.
UCN-1/2-98 -SB	Satin Brass	1 Pc.



U-Channel - 3/8"

- For 3/8" Glass, 3/4" (19mm) high profile deep U channel
- Provides support to shower enclosures without touching the ceiling

Item #	Finish	Pack
UCN-3/8-98 -CH	Chrome	1 Pc.
UCN-3/8-98 -BN	Brushed Nickel	1 Pc.
UCN-3/8-98 -MBL	Matte Black	1 Pc.
UCN-3/8-98 -SB	Satin Brass	1 Pc.
UCN-3/8-98-SG	Space Gray	1 Pc.



U-Channel -E-Commerce 3/8" Glass High Profile Deep U-Channel -76"

- Accomodates 3/8" glass
- Deep 3/4" height
- New 76" length

Item #	Finish	Pack
UCN-3/8-E-76H-CH	Chrome	1 Pc.
UCN-3/8-E-76H-BN	Brushed Nickel	1 Pc.
UCN-3/8-E-76H-MBL	Matte Black	1 Pc.
UCN-3/8-E-76H-SB	Satin Brass	1 Pc.



U-Channel -E-Commerce 3/8" Glass High Profile Deep U-Channel -76"

- Accomodates 3/8" glass
- Deep 3/4" height
- New 80" length

Item #	Finish	Pack
UCN-3/8-E-80H-CH	Chrome	1 Pc.
UCN-3/8-E-80H-BN	Brushed Nickel	1 Pc.
UCN-3/8-E-80H-MBL	Matte Black	1 Pc.
UCN-3/8-E-80H-SB	Satin Brass	1 Pc.



J Channel for 1/4" Mirror (3/8 Depth) Face

- Length: 144"

Item #	Finish	Pack
JCN-3/8-144-CH	Chrome	1 Pc.
JCN-3/8-144-BN	Brushed Nickel	1 Pc.
JCN-3/8-144-MBL	Matte Black	1 Pc.

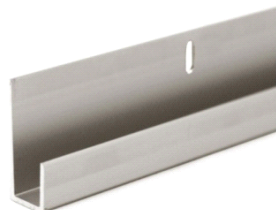

J Channel for 1/4" Mirror (5/8 Depth) Face

- Length: 144"

Item #	Finish	Pack
JCN-5/8-144-CH	Chrome	1 Pc.
JCN-5/8-144-BN	Brushed Nickel	1 Pc.
JCN-5/8-144-MBL	Matte Black	1 Pc.

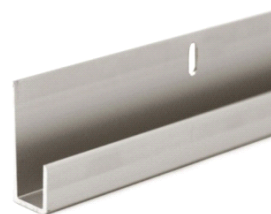

1" L Profile Threshold - 98"

- Length: 98"
- 1" wide

Item #	Finish	Pack
CTHLD-1-98-CH	Chrome	1 Pc./Box
CTHLD-1-98-BN	Brushed Nickel	1 Pc./Box
CTHLD-1-98-MBL	Matte Black	1 Pc./Box



1-1/2" L Profile Threshold - 98"

- Length: 98"
- 1-1/2" wide

Item #	Finish	Pack
CTHLD-1 1/2-98-CH	Chrome	1 Pc./Box
CTHLD-1 1/2-98-BN	Brushed Nickel	1 Pc./Box
CTHLD-1 1/2-98-MBL	Matte Black	1 Pc./Box



1/4" Aluminum L-Bar Extrusion

- 10' (3 m) stock length

Item #	Finish	Pack
LCN-120-BN	Brushed Nickel	1 Pc./Box



Shower Door L-Profile Threshold 35"

- Prevent water from escaping enclosure
- Standard 35" length

Item #	Finish	Pack
TH-L-35-SB	Satin Brass	1 Pc./Box



Shower Door L-Profile Threshold 80"

- Prevents water from escaping enclosure
- New 80" length

Item #	Finish	Pack
TH-L-80-CH	Chrome	1 Pc./Box
TH-L-80-BN	Brushed Nickel	1 Pc./Box
TH-L-80-MBL	Matte Black	1 Pc./Box
TH-L-80-SB	Satin Brass	1 Pc./Box



Glass Support Bars

36" Glass to Ceiling Round Support Bar

- Length: 36"
- For 3/8" to 1/2" thick glass

Item #	Finish	Pack
SPB36CE-CH	Chrome	1 Pc./Box
SPB36CE-BN	Brushed Nickel	1 Pc./Box
SPB36CE-MBL	Matte Black	1 Pc./Box
SPB36CE-SB	Satin Brass	1 Pc./Box



Wall to Glass Round Support Bar

- 16" - 24" glass to wall brace
- For 3/8" glass only

Item #	Finish	Pack
SPB24ADJ-CH	Chrome	1 Pc./Box
SPB24ADJ-BN	Brushed Nickel	1 Pc./Box



Wall to Glass Round Support Bar

- 16" - 24" glass to wall brace
- For 3/8" to 1/2" thick glass

Item #	Finish	Pack
SPB24ADJ-MBL	Matte Black	1 Pc./Box
SPB24ADJ-SB	Satin Brass	1 Pc./Box



24" Wall to Glass Square Support Bar - L Shaped

- 16" - 24" glass to wall brace
- For 3/8" to 1/2" thick glass

Item #	Finish	Pack
SPB24L-CH	Chrome	1 Pc./Box
SPB24L-BN	Brushed Nickel	1 Pc./Box
SPB24L-MBL	Matte Black	1 Pc./Box
SPB24L-SB	Satin Brass	1 Pc./Box



Wall to Glass Square Support Bar

- 47-1/4" length
- For 5/16" to 3/8" thick glass

Item #	Finish	Pack
SPB49ADJ-CH	Chrome	1 Pc./Box
SPB49ADJ-BN	Brushed Nickel	1 Pc./Box
SPB49ADJ-MBL	Matte Black	1 Pc./Box
SPB49ADJ-SB	Satin Brass	1 Pc./Box
SPB49ADJ-SG	Space Gray	1 Pc./Box



Glass to Glass Square Support Bar

- 47-1/4" length
- For 3/8" glass only

Item #	Finish	Pack
SPB49ADJ02-CH	Chrome	1 Pc./Box
SPB49ADJ02-BN	Brushed Nickel	1 Pc./Box
SPB49ADJ02-MBL	Matte Black	1 Pc./Box
SPB49ADJ02-SB	Satin Brass	1 Pc./Box



6" x 6" Square Pull Handle

- For 1/4" to 1/2" (6 to 12 mm) glass
- No washers

Item #	Finish	Pack
HSQ6X6-CH	Chrome	1 Pc./Box
HSQ6X6-BN	Brushed Nickel	1 Pc./Box
HSQ6X6-MBL	Matte Black	1 Pc./Box
HSQ6X6-SB	Satin Brass	1 Pc./Box



8" x 8" Square Pull Handle

- For 1/4" to 1/2" (6 to 12 mm) glass
- No washers

Item #	Finish	Pack
HSQ8X8-CH	Chrome	1 Pc./Box
HSQ8X8-BN	Brushed Nickel	1 Pc./Box
HSQ8X8-MBL	Matte Black	1 Pc./Box
HSQ8X8-SB	Satin Brass	1 Pc./Box
HSQ8X8-SG	Space Gray	1 Pc./Box
HSQ8X8-BBRZ	Brushed Bronze	1 Pc./Box
HSQ8X8-PN	Polished Nickel	1 Pc./Box

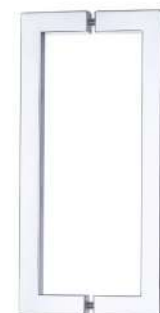

6" x 6" Tubular Pull Handle with Metal Washers

- For 1/4"-1/2" glass
- 3/4" (19 mm) diameter

Item #	Finish	Pack
HBM6X6-CH	Chrome	1 Pc./Box
HBM6X6-BN	Brushed Nickel	1 Pc./Box
HBM6X6-MBL	Matte Black	1 Pc./Box
HBM6X6-SB	Satin Brass	1 Pc./Box
HBM6X6-SG	Space Gray	1 Pc./Box
HBM6X6-BBRZ	Brushed Bronze	1 Pc./Box



8" x 8" Tubular Pull Handle with Metal Washers

- For 1/4"-1/2" glass
- 3/4" (19 mm) diameter

Item #	Finish	Pack
HBM8X8-CH	Chrome	1 Pc./Box
HBM8X8-BN	Brushed Nickel	1 Pc./Box
HBM8X8-MBL	Matte Black	1 Pc./Box
HBM8X8-SB	Satin Brass	1 Pc./Box
HBM8X8-GP	Gold Plated	1 Pc./Box
HBM8X8-SG	Space Gray	1 Pc./Box
HBM8X8-PC	Polished Copper	1 Pc./Box
HBM8X8-ABC	Antique Brush Copper	1 Pc./Box
HBM8X8-BBRZ	Brushed Bronze	1 Pc./Box
HBM8X8-PN	Polished Nickel	1 Pc./Box



8" Round Mitered Corner Back-To-Back Pull Handle

- For 1/4" to 1/2" glass

Item #	Finish	Pack
HMT8X8-CH	Chrome	1 Pc./Box
HMT8X8-BN	Brushed Nickel	1 Pc./Box
HMT8X8-MBL	Matte Black	1 Pc./Box
HMT8X8-SB	Satin Brass	1 Pc./Box



Square Single Sided Handle

- 8" CTC hole spacing
- For 1/4" to 1/2" glass
- Single sided door handle

Item #	Finish	Pack
HSQ8-CH	Chrome	1 Pc./Box
HSQ8-BN	Brushed Nickel	1 Pc./Box
HSQ8-MBL	Matte Black	1 Pc./Box
HSQ8-SB	Satin Brass	1 Pc./Box



Square Single Sided Handle

- 12" CTC hole spacing
- For 1/4" to 1/2" glass
- Single sided door handle

Item #	Finish	Pack
HSQ12-CH	Chrome	1 Pc./Box
HSQ12-BN	Brushed Nickel	1 Pc./Box
HSQ12-MBL	Matte Black	1 Pc./Box
HSQ12-SB	Satin Brass	1 Pc./Box



Tubular Single Sided Handle

- 8" CTC hole spacing
- For 1/4" to 1/2" glass
- Single sided door handle

Item #	Finish	Pack
HBM8-CH	Chrome	1 Pc./Box
HBM8-BN	Brushed Nickel	1 Pc./Box
HBM8-MBL	Matte Black	1 Pc./Box



Tubular Single Ladder Style Pull Handle

- 8" CTC hole spacing
- 12" overall length

Item #	Finish	Pack
HLP8-CH	Chrome	1 Pc./Box
HLP8-BN	Brushed Nickel	1 Pc./Box
HLP8-MBL	Matte Black	1 Pc./Box
HLP8-SB	Satin Brass	1 Pc./Box



12" x 12" Tubular Ladder Style Pull Handle

- 8" CTC hole spacing.
- For 5/16" to 1/2" (8 to 12 mm) glass

Item #	Finish	Pack
HLP8X8-CH	Chrome	1 Pc./Box
HLP8X8-BN	Brushed Nickel	1 Pc./Box
HLP8X8-MBL	Matte Black	1 Pc./Box
HLP8X8-SB	Satin Brass	1 Pc./Box
HLP8X8-SG	Space Gray	1 Pc./Box
HLP8X8-BBRZ	Brushed Bronze	1 Pc./Box



16" x 16" Tubular Ladder Style Pull Handle

- 12" CTC hole spacing.
- For 5/16" to 1/2" (8 to 12 mm) glass

Item #	Finish	Pack
HLP12X12-CH	Chrome	1 Pc./Box
HLP12X12-BN	Brushed Nickel	1 Pc./Box
HLP12X12-MBL	Matte Black	1 Pc./Box
HLP12X12-SB	Satin Brass	1 Pc./Box



20" Square Towel Bar

- Single sided towel bar
- 3/4" x 3/4"
- For 1/4" - 1/2" glass

Item #	Finish	Pack
TBS20-CH	Chrome	1 Pc./Box
TBS20-BN	Brushed Nickel	1 Pc./Box
TBS20-MBL	Matte Black	1 Pc./Box
TBS20-SB	Satin Brass	1 Pc./Box
TBS20-SG	Space Gray	1 Pc./Box
TBS20-BBRZ	Brushed Bronze	1 Pc./Box



22" Square Towel Bar

- Single sided towel bar
- 3/4" x 3/4"
- For 1/4" - 1/2" glass

Item #	Finish	Pack
TBS22-CH	Chrome	1 Pc./Box
TBS22-BN	Brushed Nickel	1 Pc./Box
TBS22-MBL	Matte Black	1 Pc./Box



24" Square Towel Bar

- Single sided towel bar
- 3/4" x 3/4"
- For 1/4" - 1/2" glass

Item #	Finish	Pack
TBS24-CH	Chrome	1 Pc./Box
TBS24-BN	Brushed Nickel	1 Pc./Box
TBS24-MBL	Matte Black	1 Pc./Box
TBS24-SB	Satin Brass	1 Pc./Box
TBS24-SG	Space Gray	1 Pc./Box



20' towel bar

- Single sided towel bar for UKD08
- For 1/4"-1/2"(6mm-12mm) glass

Item #	Finish	Pack
HTB20UKD08-CH	Chrome	1 Pc./Box
HTB20UKD08-BN	Brushed Nickel	1 Pc./Box
HTB20UKD08-MBL	Matte Black	1 Pc./Box



18" Tubular Towel Bar with Metal Washer

- 3/4" diameter
- For 1/4" - 1/2" glass

Item #	Finish	Pack
TBR18W-CH	Chrome	1 Pc./Box
TBR18W-BN	Brushed Nickel	1 Pc./Box
TBR18W-MBL	Matte Black	1 Pc./Box
TBR18W-SB	Satin Brass	1 Pc./Box



20" Tubular Towel Bar with Metal Washer

- 3/4" diameter
- For 1/4" - 1/2" glass

Item #	Finish	Pack
TBR20W-CH	Chrome	1 Pc./Box
TBR20W-BN	Brushed Nickel	1 Pc./Box
TBR20W-MBL	Matte Black	1 Pc./Box
TBR20W-SB	Satin Brass	1 Pc./Box
TBR20W-BBRZ	Brushed Bronze	1 Pc./Box



22" Tubular Towel Bar with Metal Washer

- 3/4" diameter
- For 1/4" - 1/2" glass

Item #	Finish	Pack
TBR22W-CH	Chrome	1 Pc./Box
TBR22W-BN	Brushed Nickel	1 Pc./Box
TBR22W-MBL	Matte Black	1 Pc./Box



24" Tubular Towel Bar with Metal Washer

- 3/4" diameter
- For 1/4" - 1/2" glass

Item #	Finish	Pack
TBR24W-CH	Chrome	1 Pc./Box
TBR24W-BN	Brushed Nickel	1 Pc./Box
TBR24W-MBL	Matte Black	1 Pc./Box



24" Tubular Ladder Style Towel Bar

- 1" diameter x 24" long
- 20" CTC hole spacing
- For 1/4" - 1/2" glass

Item #	Finish	Pack
TBL20-CH	Chrome	1 Pc./Box
TBL20-BN	Brushed Nickel	1 Pc./Box
TBL20-MBL	Matte Black	1 Pc./Box
TBL20-SB	Satin Brass	1 Pc./Box



24" Towel Bar for UKD07N

- Hole diameter: 3/4"

Item #	Finish	Pack
HTB24UKD07N-CH	Chrome	1 Pc./Box
HTB24UKD07N-BN	Brushed Nickel	1 Pc./Box
HTB24UKD07N-MBL	Matte Black	1 Pc./Box
HTB24UKD07N-SB	Satin Brass	1 Pc./Box



20" Towel Bar for UKD06

- Hole diameter: 13/16"

Item #	Finish	Pack
HTB20UKD06-CH	Chrome	1 Pc./Box
HTB20UKD06-BN	Brushed Nickel	1 Pc./Box
HTB20UKD06-MBL	Matte Black	1 Pc./Box
HTB20UKD06-SB	Satin Brass	1 Pc./Box



18" Tubular Back-to-Back Tower Bar with Metal Washer

- 3/4" diameter
- For 1/4" - 1/2" glass

Item #	Finish	Pack
HBM18X18-CH	Chrome	1 Pc./Box
HBM18X18-BN	Brushed Nickel	1 Pc./Box
HBM18X18-MBL	Matte Black	1 Pc./Box



6" x 18" Square Pull Handle/Towel Bar

- 3/4" x 3/4"
- For 1/4" - 1/2" glass

Item #	Finish	Pack
HTS6X18-CH	Chrome	1 Pc./Box
HTS6X18-BN	Brushed Nickel	1 Pc./Box
HTS6X18-MBL	Matte Black	1 Pc./Box



8" x 18" Square Pull Handle/Towel Bar

- 3/4" x 3/4"
- For 1/4" - 1/2" glass

Item #	Finish	Pack
HTS8X18-CH	Chrome	1 Pc./Box
HTS8X18-BN	Brushed Nickel	1 Pc./Box
HTS8X18-MBL	Matte Black	1 Pc./Box
HTS8X18-SB	Satin Brass	1 Pc./Box



Towel Bars/Door Knobs

8" x 24" Square Pull Handle/Towel Bar

- 3/4" x 3/4"
- For 1/4" - 1/2" glass

Item #	Finish	Pack
HTS8X24-CH	Chrome	1 Pc./Box
HTS8X24-BN	Brushed Nickel	1 Pc./Box
HTS8X24-MBL	Matte Black	1 Pc./Box
HTS8X24-SB	Satin Brass	1 Pc./Box
HTS8X24-BBRZ	Brushed Bronze	1 Pc./Box



6" x 18" Tubular Pull Handle/Towel Bar

- 3/4" diameter
- For 1/4" - 1/2" glass

Item #	Finish	Pack
HTR6X18-CH	Chrome	1 Pc./Box
HTR6X18-BN	Brushed Nickel	1 Pc./Box
HTR6X18-MBL	Matte Black	1 Pc./Box



8" x 18" Tubular Pull Handle/Towel Bar

- 3/4" diameter
- For 1/4" - 1/2" glass

Item #	Finish	Pack
HTR8X18-CH	Chrome	1 Pc./Box
HTR8X18-BN	Brushed Nickel	1 Pc./Box
HTR8X18-MBL	Matte Black	1 Pc./Box
HTR8X18-SB	Satin Brass	1 Pc./Box
HTR8X18-PN	Polished Nickel	1 Pc./Box



8" x 24" Tubular Pull Handle/Towel Bar

- 3/4" diameter
- For 1/4" - 1/2" glass

Item #	Finish	Pack
HTR8X24-CH	Chrome	1 Pc./Box
HTR8X24-BN	Brushed Nickel	1 Pc./Box
HTR8X24-MBL	Matte Black	1 Pc./Box
HTR8X24-SB	Satin Brass	1 Pc./Box
HTR8X24-BBRZ	Brushed Bronze	1 Pc./Box
HTR8X24-PN	Polished Nickel	1 Pc./Box



Single Sided Door Knob

- Fits 1/4" to 1/2" (6 to 12 mm) thick glass
- 1/2" diameter hole in glass
- Solid brass material

Item #	Finish	Pack
KNB001S-CH	Chrome	1 Pc./Box
KNB001S-BN	Brushed Nickel	1 Pc./Box
KNB001S-MBL	Matte Black	1 Pc./Box



Back-to-Back E-Z Grip Door Knob

- Fits 1/4" to 1/2" (6 to 12 mm) thick glass
- 1/2" diameter hole in glass
- Solid brass material

Item #	Finish	Pack
KNB001D-CH	Chrome	1 Pc./Box
KNB001D-BN	Brushed Nickel	1 Pc./Box
KNB001D-MBL	Matte Black	1 Pc./Box



Cylinder Style Single Sided Door Knob

- Fits 1/4" to 1/2" (6 to 12 mm) thick glass
- 1/2" diameter hole in glass
- Solid brass material

Item #	Finish	Pack
KNB002S-CH	Chrome	1 Pc./Box
KNB002S-BN	Brushed Nickel	1 Pc./Box
KNB002S-MBL	Matte Black	1 Pc./Box



Cylinder Style Back-to-Back Door Knob With Plastic Sleeve

- Fits 1/4" to 1/2" (6 to 12 mm) thick glass
- 1/2" diameter hole in glass
- Solid brass material

Item #	Finish	Pack
KNB002D-CH	Chrome	1 Pc./Box
KNB002D-BN	Brushed Nickel	1 Pc./Box
KNB002D-MBL	Matte Black	1 Pc./Box



Traditional Style Single Sided Door Knob

- Fits 1/4" to 1/2" (6 to 12 mm) thick glass
- 1/2" diameter hole in glass
- Solid brass material

Item #	Finish	Pack
KNB003S-CH	Chrome	1 Pc./Box
KNB003S-BN	Brushed Nickel	1 Pc./Box
KNB003S-MBL	Matte Black	1 Pc./Box



Traditional Style Back-to-Back Door Knob

- Fits 1/4" to 1/2" (6 to 12 mm) thick glass
- 1/2" diameter hole in glass
- Solid brass material

Item #	Finish	Pack
KNB003D-CH	Chrome	1 Pc./Box
KNB003D-BN	Brushed Nickel	1 Pc./Box
KNB003D-MBL	Matte Black	1 Pc./Box



Contemporary Style Single Sided Door Knob

- Fits 1/4" to 1/2" (6 to 12 mm) thick glass
- 1/2" diameter hole in glass
- Solid brass material

Item #	Finish	Pack
KNB004S-CH	Chrome	1 Pc./Box
KNB004S-BN	Brushed Nickel	1 Pc./Box
KNB004S-MBL	Matte Black	1 Pc./Box



Contemporary Style Back- to-Back Door Knob

- Fits 1/4" to 1/2" (6 to 12 mm) thick glass
- 1/2" diameter hole in glass
- Solid brass material

Item #	Finish	Pack
KNB004D-CH	Chrome	1 Pc./Box
KNB004D-BN	Brushed Nickel	1 Pc./Box
KNB004D-MBL	Matte Black	1 Pc./Box



Cone Style Single Sided Door Knob

- Fits 1/4" to 1/2" (6 to 12 mm) thick glass
- 1/2" diameter hole in glass
- Solid brass material

Item #	Finish	Pack
KNB005S-CH	Chrome	1 Pc./Box
KNB005S-BN	Brushed Nickel	1 Pc./Box
KNB005S-MBL	Matte Black	1 Pc./Box



Cone Style Back-to-Back Door Knob

- Fits 1/4" to 1/2" (6 to 12 mm) thick glass
- 1/2" diameter hole in glass
- Solid brass material

Item #	Finish	Pack
KNB005D-CH	Chrome	1 Pc./Box
KNB005D-BN	Brushed Nickel	1 Pc./Box
KNB005D-MBL	Matte Black	1 Pc./Box



Singe Sided Finger Pull for UKD06

- Fits 1/4" to 3/8" (6 to 10 mm) thick glass
- 1/2" diameter hole in glass
- Single sided finger pull for UKD06 glass
- 304 stainless steel

Item #	Finish	Pack
KNB006S-CH	Chrome	1 Pc./Box
KNB006S-BN	Brushed Nickel	1 Pc./Box
KNB006S-MBL	Matte Black	1 Pc./Box



Back-To-Back Paddle Knob

- Fits 5/16" to 1/2" (8 to 12 mm) thick glass
- 3/4" (19mm) diameter hole in glass
- Solid brass material

Item #	Finish	Pack
KNB007D-CH	Chrome	1 Pc./Box
KNB007D-BN	Brushed Nickel	1 Pc./Box
KNB007D-MBL	Matte Black	1 Pc./Box
KNB007D-SB	Satin Brass	1 Pc./Box



Sliding Door Thru-Glass Pull Handle

- Diameter: 2-5/16"
- For 5/16" to 3/8" (8 to 10 mm) glass

Item #	Finish	Pack
FNP01-CH	Chrome	1 Pc./Box
FNP01-BN	Brushed Nickel	1 Pc./Box
FNP01-MBL	Matte Black	1 Pc./Box
FNP01-SB	Satin Brass	1 Pc./Box
FNP01-SG	Space Gray	1 Pc./Box



Sleeve-Over Robe Hook

- Mounts on top of 5/16" to 1/2" (8-12 mm) thick tempered glass
- Includes clear gaskets

Item #	Finish	Pack
BRA-RH001-CH	Chrome	1 Pc./Box
BRA-RH001-BN	Brushed Nickel	1 Pc./Box
BRA-RH001-MBL	Matte Black	1 Pc./Box



Through Glass Robe Hook

- Adjusts for through glass mounting installation for 5/16" to 1/2" (8-12 mm) glass
- 1/2" diameter hole is required

Item #	Finish	Pack
BRA-RH002-CH	Chrome	1 Pc./Box
BRA-RH002-BN	Brushed Nickel	1 Pc./Box
BRA-RH002-MBL	Matte Black	1 Pc./Box



Sealants / Cleaners

300ml, Transparent Silicone Sealant



10.1 oz
SLC-300

CRL Clear Dow Corning Glazing Sealant



10.3 oz
SLC-DC1C

CRL Palmer Qwikset Mirror - Mastic



10.1 oz
ADH-PM711N

CRL Surface Protector - 16 oz.



CNS-TPC16

Invisible Shield Nano - Scale Glass Coating



19 oz
CNS-54215

Diamond Blue Repellent Wash



CNS-016

CRL 1973 Ammoniated Aerosol Glass Cleaner



CNS-1973

CRL Repel Cleaner & Protectant



CNS-17740

Diamond Luster Restoration Cream



CNS-017

Enduro Shield Glass Treatment Sample



CNS-ES-S01

8" Dia. Suction Cup Lifter - Metal Handle

- Strong suction to lift glass, marble, or tiles
- Red line safe indicator - 125lbs capacity flat surface lifter



Titanium Drill Bit

- Arrow point for precision and sharper starts
- U-shaped helix for faster chip removal
- Tri-flat shank for stronger chuck hold



15' X 1.5" RATCHET TIE DOWN W/J HOOK



15' X 1.5" RATCHET TIE DOWN W/PLATE HOOK



25' Compact Tape Measure



LINT FREE HEAVY DUTY GLASS WIPES (100)



1/16"x 2" Plastic Horseshoe Shims

100pcs/Box

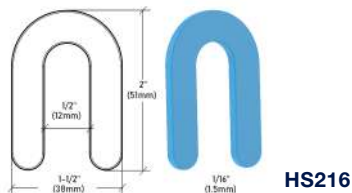

1/8"x 2" Plastic Horseshoe Shims

100pcs/Box

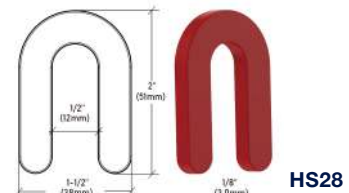

1/4"x 4" Plastic Horseshoe Shims

100pcs/Box

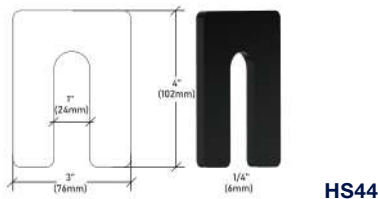

1/4" Square Beveled Clear Plastic Mirror Clip

100pcs/Bag



GLASS HANDLING GLOVES - MEDIUM



UKWG300-M

GLASS HANDLING GLOVES - LARGE



UKWG300-L

.040" x 1/4" x 2" Clear Plastic Setting Blocks

100pcs/Bag



UPSB040

.080" x 1/4" x 2" Clear Plastic Setting Blocks

100pcs/Bag



UPSB080

1/8" x 1/4" x 2" Clear Plastic Setting Blocks

100pcs/Bag



UPSB125

5/32" x 1/4" x 2" Clear Plastic Setting Blocks

100pcs/Bag



UPSB156

1/4" x 1/4" x 2" Clear Plastic Setting Blocks

100pcs/Bag



UPSB250

3/8" x 1/4" x 2" Clear Plastic Setting Blocks

100pcs/Bag



JPSB375

Transparent 1/4" x .040" x 36' Acrylic Very Hi-Bond Adhesive Tape



AAT1404036

045" x 3/4" x 108' Acrylic Foam Very Hi-Bond Adhesive Cladding Tape



CAT4534

045"x3/8"x 108' Acrylic Foam Very Hi-Bond Adhesive Cladding Tape



CAT4538

Clear Single Duplex Plug Acrylic Mirror Plate



MP103

Clear Single Toggle Switch Acrylic Mirror Plate



MP101

Clear Single Designer Acrylic Mirror Plate



MP102

Clear Double Designer Acrylic Mirror Plate



MP202

79" x 66" Double Sided Shop Glass Cart



DGC7966

39" x 43" Double Sided Shop Glass Cart



DGC3943

59" x 51" Double Sided Shop Glass Cart



DGC5951

Satin Anodized 2-5/8" x 9-5/8" Standard Mail Slot / Aluminum



CMS100A

Zinc Plated Wood Mount L-Angle Kit 1/2"-13



CBSWML1

Aluminum Base Shoe Drain Block

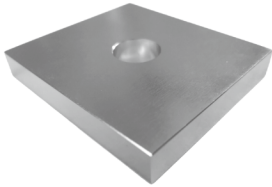

CBSDB01

4 Pcs Screws and 4 Pcs Screw Expanding for Unikoo Hinges Series

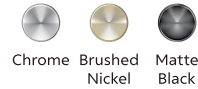

SH10H

Shower Hardware Color Sample Kit 6 Finished: CH, BN, MBL, SB, SG, BBRZ



UKCSK

1/4" Hole, 1-1/2" Length 10-12 Screw Expanding PVC Green Screw Anchors



ESA2001

WALL MOUNTED LED MIRROR



BRA-A3636/BRA-A4824/BRA-A6030/BRA-A7236

- 36" X 36" / 48" x 24" / 60" x 30" / 72" x 36"
- LED Mirror
- Dimmable, 3 Color temperature warm -nature-white
- Defogger function
- Copper-free 1/4" mirror with safety film



BRA-AR2424/BRA-AR3232

- 24" x 24" / 32" x 32"
- Round LED backlit Mirror
- Dimmable, 3 Color temperature warm -nature-white
- Defogger function
- Copper-free 1/4" mirror with safety film



BRA-A3628

- 36" x 28" Rectangular LED backlit Mirror
- Dimmable, 3 Color temperature warm -nature-white
- Defogger function
- Copper-free 1/4" mirror with safety film

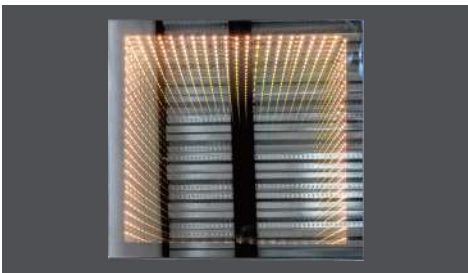

BRA-INF-A1515

- 15" W x 15" H
- LED infinity wall mirror

CUSTOM MADE MIRROR



- Custom size mirror
- Made to order

WALL MOUNTED LED MIRROR



BRA-AF4433-SB / BRA-AF4433-SG



44" W x 33" H
Rectangular stainless steel framed led light anti-fog bathroom vanity mirror



BRA-AF2432

24" W x 32" H
Rectangular aluminum framed led light anti-fog bathroom vanity mirror



BRA-AF2424

24" W x 24" H
Round stainless steel framed led light anti-fog bathroom vanity mirror



BRA-AR2424-02

24" W x 24" H
Round frameless backlit led light anti-fog bathroom vanity mirror



BRA-A1927

19-1/4" W x 27-1/4" H
Surface mount right led light anti-fog medicine cabinet



MIRROR4896



Annealed 48" x 96" x 1/4" Mirror



LOS ANGELES

4610 Santa Anita Ave, El Monte, CA 91731 | 626.522.1551 | info@unikoogroup.com

ORANGE COUNTY

1820 S Santa Fe St, Santa Ana, CA 92705 | 888.404.5533 | infooc@unikoogroup.com

NEW JERSEY

1090 Lousons Rd, Union, NJ 07083 | 908.641.9588 | infonj@unikoogroup.com

www.unikoogroup.com