



2026
Edition

S UNIKOO
GLASS & HARDWARE

COMMERCIAL SYSTEM

Welcome to UNIKOO

UNIKOO, based in California, specializes in the fabrication and distribution of glass and hardware to meet the unique needs of the Shower Door Enclosure and Commercial Railing industries. We proudly serve the Glass, General Contractors, and Kitchen and Tile industries.

Our Offerings

We provide a diverse range of products with numerous finishes, catering to specific projects for homes, commercial storefronts, apartment complexes, condos, and hotels.

The possibilities are endless with UNIKOO.

Our Experience

With over 25 years of employee technical experience, we are equipped to assist with any project. Since our establishment in 2017 in an 2800 sq. ft. office, we have grown substantially. Today, we operate over 60,000 sq. ft. of manufacturing space and two locations in Southern California, totaling over 100,000 sq. ft. of warehouse distribution space across the United States. This growth positions us as a leading provider of quality glass and hardware, with plans to expand further to better serve every corner of the country.

Our Products

We invite you to explore our extensive product range, including pristine quality stock and custom-size glass, luxurious shower enclosure units, modern style hand railing hardware, and essential accessories to complete your project. Visit us at any of our locations or online.

Our Commitment

Our website offers an easy-to-navigate interface, simplifying the custom order process.

We take pride in offering same-day processing and shipping for in-stock and available products, thanks to our dedicated team.

Experience the quality and service of UNIKOO, your trusted partner in glass and hardware solutions.



Our Vision

To be a leading provider of glass and hardware solutions, recognized for our unwavering commitment to customers, continuous innovation, quality-driven products, and a collaborative culture that drives success and growth.



Our Mission

To deliver exceptional glass and hardware solutions by upholding customer commitment, fostering creativity in every innovation, crafting value through quality and reliability, and promoting collaboration across all teams to achieve success together, driven by excellence.

Our Core Values

- Customer Commitment-Always prioritize the needs and satisfaction of our customers.
- Creativity-Embrace innovation and continuous improvement in everything we do.
- Crafting Value - Focus on providing high-quality solutions that offer real value to our customers.
- Collaboration-Work together, support each other, and achieve success as one.









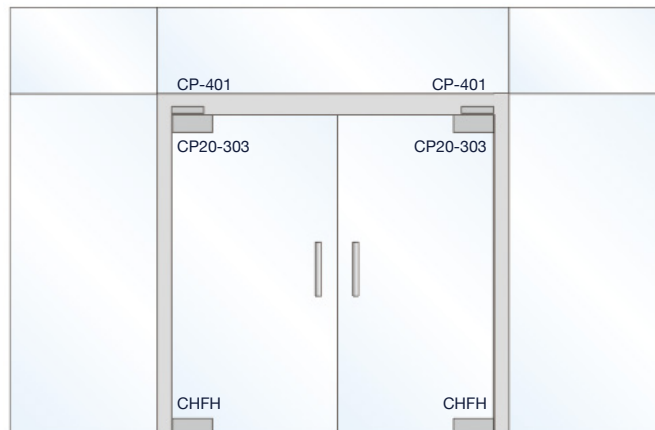
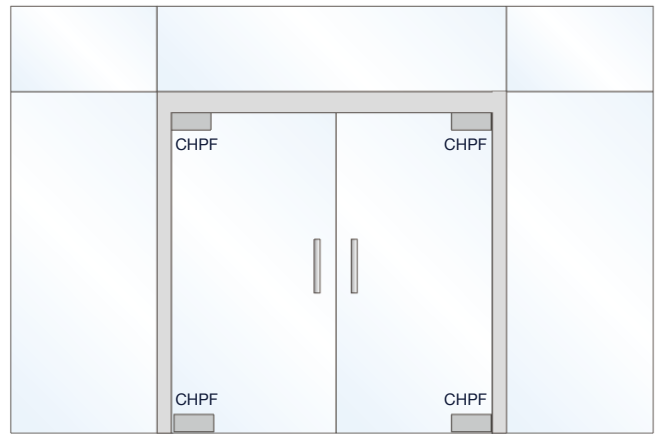
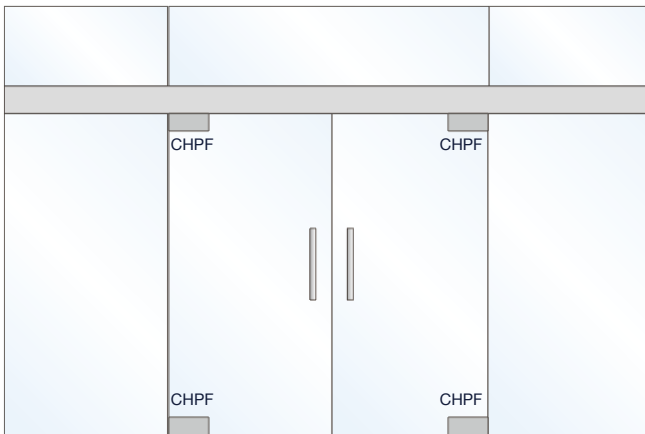



Frameless storefronts and entrances deliver a sleek, contemporary look by removing traditional framing. This design provides greater flexibility, allowing architects and designers to create distinctive, eye-catching entryways. They are ideal for various applications, including retail stores, mall fronts, hotels, arenas, museums, office buildings, restaurants, and clubs.

Product Overview

- For 3/8" or 1/2" (10 or 12 mm) glass
- To ensure public safety, we strongly advise using only tempered safety glass.
- Available in four finishes
- Option to include or exclude locks







Item#		Description
CHPF		Top And Hydraulic Bottom Patch Fitting Set with Top Pivot and Base
CP401		Top Center-Hung Free Swing Pivot
CP20-303		Top Door Patch with 303 Insert
CHFH		Commercial - Hydraulic Floor Hinge Fit For 5/16"-1/2" Glass With Hold Open At 90° Up To 150°
CHLL48X48		Ladder Pull Back-to-Back Handle with Lock-48"
CHLL60X60		Ladder Pull Back-to-Back Handle with Lock-60"
CHLP36X36		36" Ladder Pull Back-to-Back Handle
CHLP48X48		48" Ladder Pull Back-to-Back Handle
CHLP60X60		60" Ladder Pull Back-to-Back Handle
CHLP72X72		72" Ladder Pull Back-to-Back Handle
CD-10-OT		10" Offset Back-to-Back Pull Handle

Glass Entrance Systems

Top And Hydraulic Bottom Patch Fitting Set with Top Pivot and Base

Item#	Finish	Material
CHPF-CH	Chrome	Aluminum & SUS304
CHPF-BN	Brushed Nickel	
CHPF-MBL	Matte Black	

 Tempered Glass
  3/8"-1/2"
  176lbs
  42"

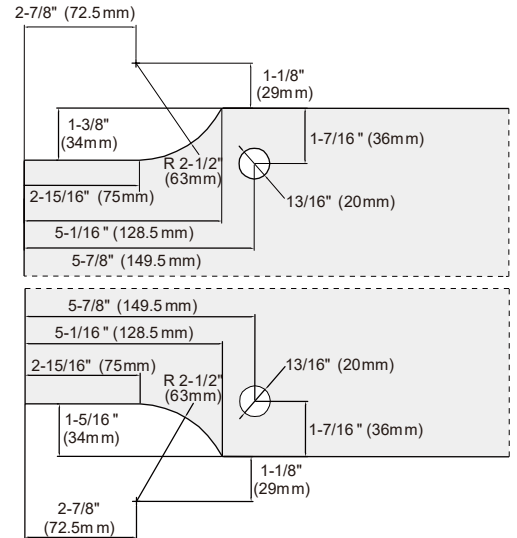
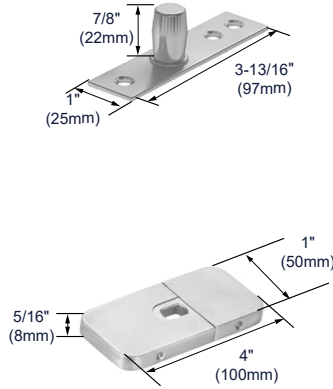
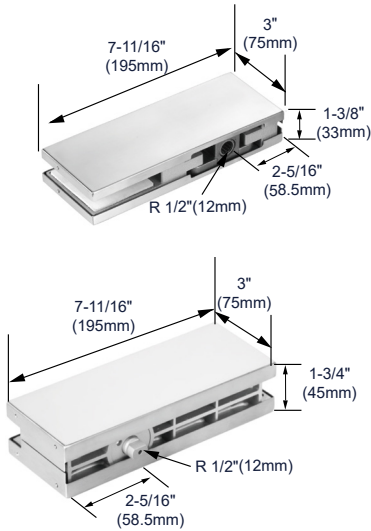

Top Center-Hung Free Swing Pivot

Item#	Finish	Material
CP-401-BN	Brushed Nickel	Aluminum & SUS304
CP-401-MBL	Matte Black	

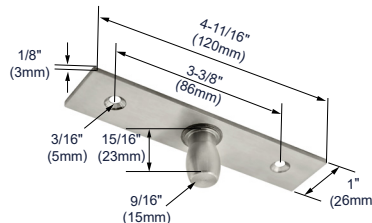



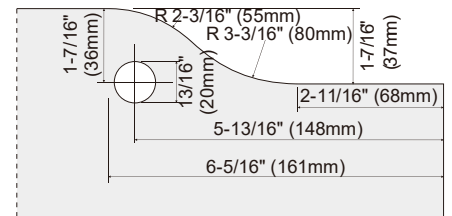
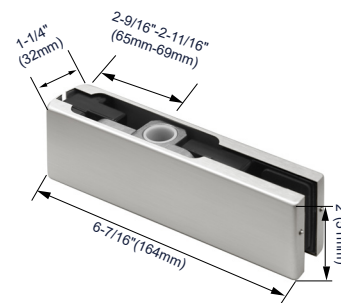

The CP-401 is required for use with the CP20-303

Top Door Patch with 303 Insert

Item#	Finish	Material
CP20-303-CH	Chrome	Aluminum & SUS304
CP20-303-BN	Brushed Nickel	
CP20-303-MBL	Matte Black	



 Tempered Glass
  3/8"-1/2"
  176lbs
  42"

Top And Hydraulic Bottom Patch Fitting Set with Top Pivot and Base

Item#	Finish	Material
CHFH-CH	Chrome	Aluminum & SUS304
CHFH-BN	Brushed Nickel	
CHFH-MBL	Matte Black	

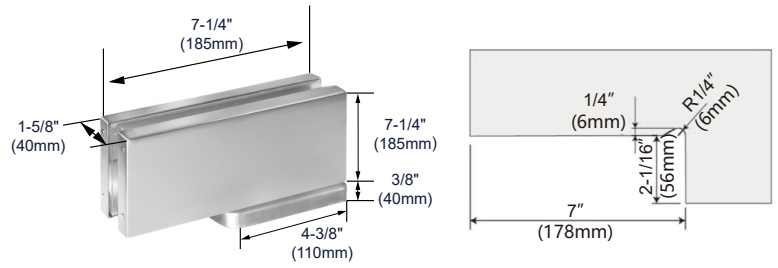

Tempered Glass



5/16"-1/2"



220.46lbs



37-3/8"



Product Overview

- For 3/8" or 1/2" (10 or 12 mm) glass
- To ensure public safety, we strongly advise using only tempered safety glass.
- Available in four finishes
- Option to include or exclude locks

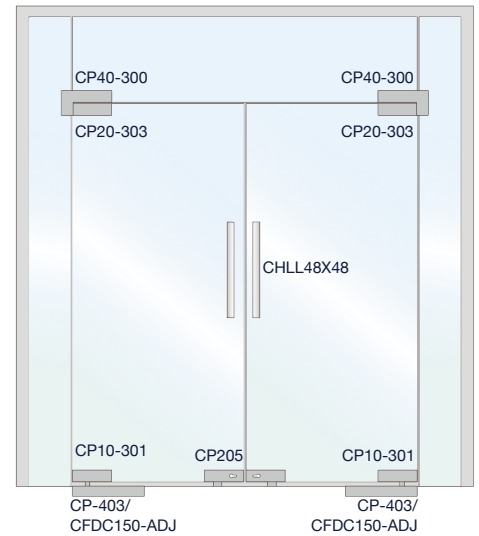

Item#		Description
CP10-301		Bottom Door Patch with 301 Insert
CP-403		Adjustable Free-Swinging Bottom Pivot
CP20-303		Top Door Patch with 303 Insert
CP40-300		Sidelite Transom Patch with 300 Insert
CP205		Bottom Patch Lock
CFDC150-ADJ		Adjustable Spring Power 90 Degree Hold Open Floor Mounted Closer
CHLL48X48		Ladder Pull Back-to-Back Handle with Lock-48"
CHLL60X60		Ladder Pull Back-to-Back Handle with Lock-60"
CHLP36X36		36" Ladder Pull Back-to-Back Handle
CHLP48X48		48" Ladder Pull Back-to-Back Handle
CHLP60X60		60" Ladder Pull Back-to-Back Handle
CHLP72X72		72" Ladder Pull Back-to-Back Handle
CD-10-OT		10" Offset Back-to-Back Pull Handle

Bottom Door Patch with 301 Insert

Item#	Finish	Material
CP10-301-CH	Chrome	Aluminum & SUS304
CP10-301-BN	Brushed Nickel	
CP10-301-MBL	Matte Black	

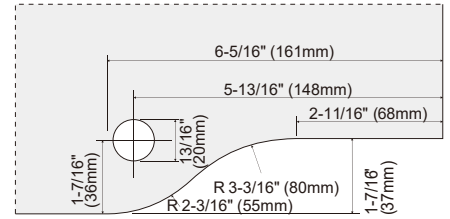
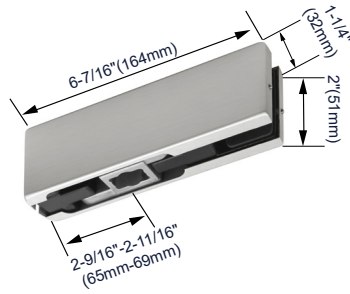

Tempered Glass



3/8"-1/2"



176lbs



42"

Adjustable Free-Swinging Bottom Pivot

Item#	Finish	Material
CP-403-BN	Brushed Nickel	Aluminum & SUS304
CP-403-MBL	Matte Black	
CP-403-SA	Satin Anodized	

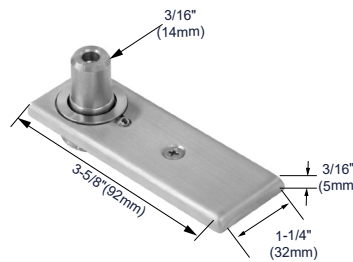

The CP-403 is required for use with the CP10-301

Top Door Patch with 303 Insert

Item#	Finish	Material
CP20-303-CH	Chrome	Aluminum & SUS304
CP20-303-BN	Brushed Nickel	
CP20-303-MBL	Matte Black	

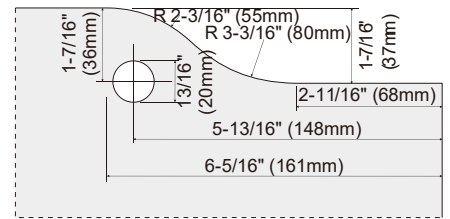
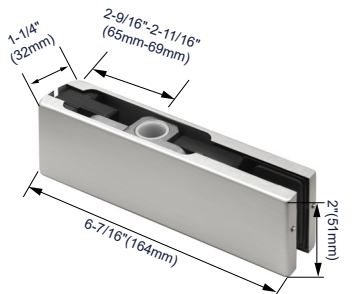

Tempered Glass



3/8"-1/2"



176lbs



42"

Adjustable Spring Power 90 Degree Hold Open Floor Mounted Closer

Item#	Material
CFDC150-ADJ	Steel & Stainless Steel

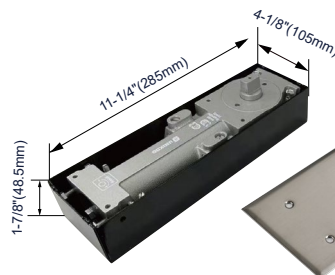

Tempered Glass



3/8"-1/2"



330.7lbs



23-5/8"-43-5/16"

Glass Entrance Systems

Sidelite Transom Patch with 300 Insert

Item#	Finish	Material
CP40-300-CH	Chrome	Aluminum & SUS304
CP40-300-BN	Brushed Nickel	
CP40-300-MBL	Matte Black	

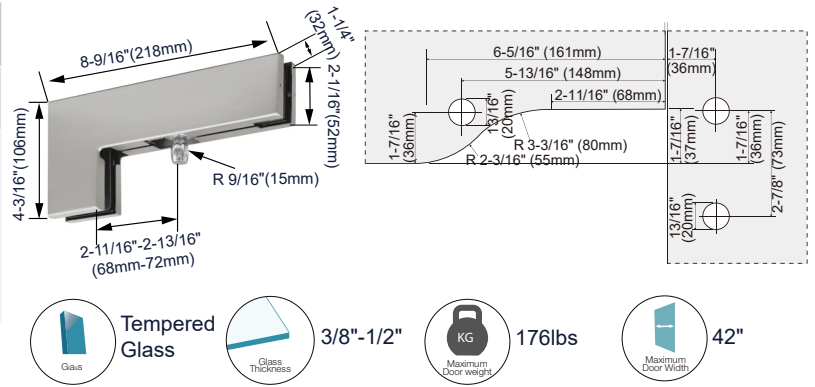

Tempered Glass 3/8" - 1/2" 176lbs 42"

Bottom Patch Lock

Item#	Finish	Material
CP205-CH	Chrom	Aluminum & SUS304
CP205-BN	Brushed Nickel	
CP205-MBL	Matte Black	

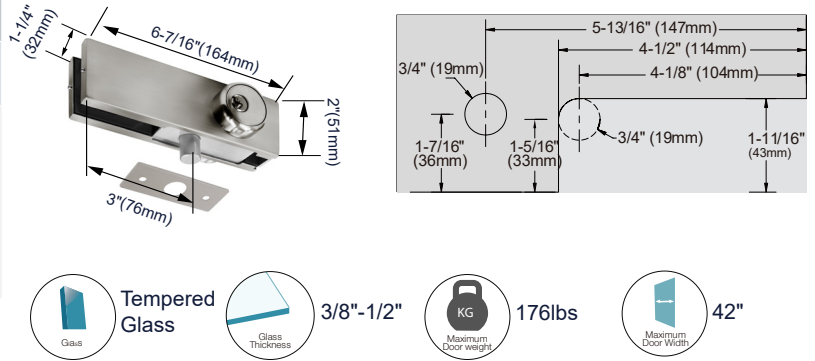

Tempered Glass 3/8" - 1/2" 176lbs 42"

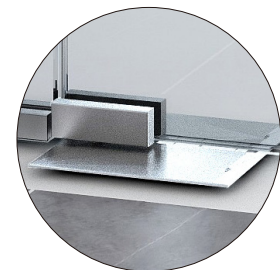
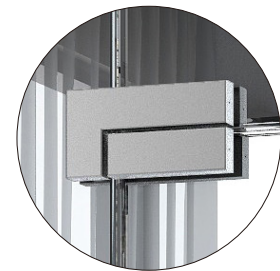

Product Overview

- For 3/8" or 1/2" (10 or 12 mm) glass
- To ensure public safety, we strongly advise using only tempered safety glass.
- Available in four finishes
- Option to include or exclude locks

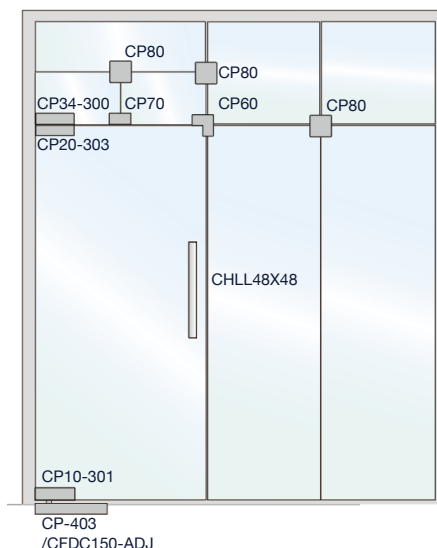

Item#		Description
CP60		Sidelite Mounted Transom Patch with Reversible Door Stop
CP80		Transom Patch Glass Panel Connector
CP34-300		Wall Mounted Transom Patch with 300 Insert
CP70		Transom Mounted Connector with Two Reversible Door Stops
CP10-301		Bottom Door Patch with 301 Insert
CP-403		Adjustable Free-Swinging Bottom Pivot
CP20-303		Top Door Patch with 303 Insert
CFDC150-ADJ		Adjustable Spring Power 90 Degree Hold Open Floor Mounted Closer
CHLL48X48		Ladder Pull Back-to-Back Handle with Lock-48"
CHLL60X60		Ladder Pull Back-to-Back Handle with Lock-60"
CHLP36X36		36" Ladder Pull Back-to-Back Handle
CHLP48X48		48" Ladder Pull Back-to-Back Handle
CHLP60X60		60" Ladder Pull Back-to-Back Handle
CHLP72X72		72" Ladder Pull Back-to-Back Handle
CD-10-OT		10" Offset Back-to-Back Pull Handle

Sidelite Mounted Transom Patch with Reversible Door Stop

Item#	Finish	Material
CP60-CH	Chrome	Aluminum & SUS304
CP60-BN	Brushed Nickel	
CP60-MBL	Matte Black	

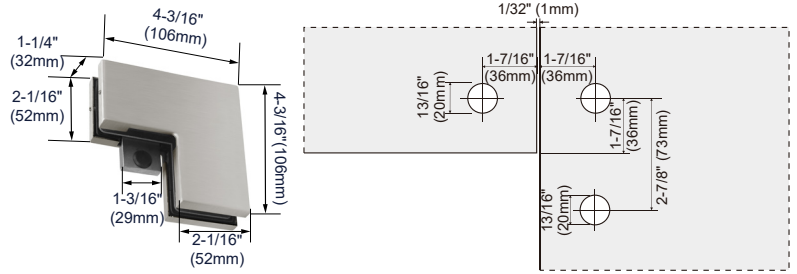

Tempered Glass
 3/8"-1/2"
 176lbs
 42"

Transom Patch Glass Panel Connector

Item#	Finish	Material
CP80-CH	Chrome	Aluminum & SUS304
CP80-BN	Brushed Nickel	
CP80-MBL	Matte Black	

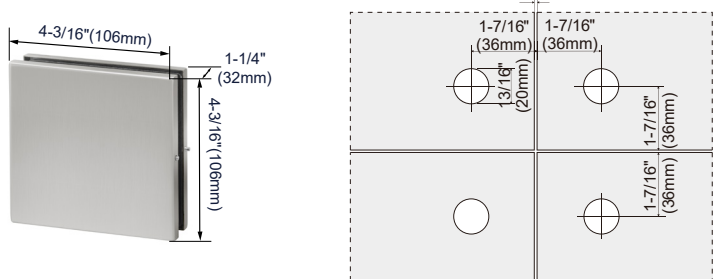

Tempered Glass
 3/8"-1/2"
 176lbs
 42"

Wall Mounted Transom Patch with 300 Insert

Item#	Finish	Material
CP34-300-CH	Chrome	Aluminum & SUS304
CP34-300-BN	Brushed Nickel	
CP34-300-MBL	Matte Black	

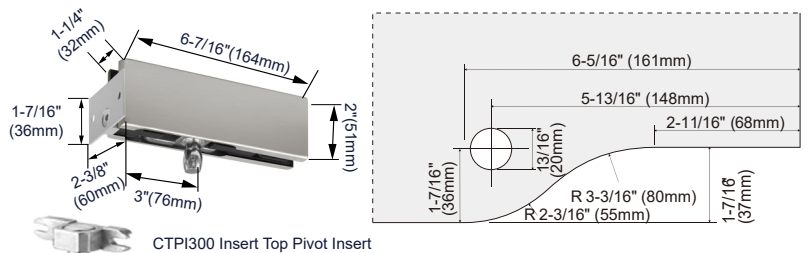

Tempered Glass
 3/8"-1/2"
 176lbs
 42"

Transom Mounted Connector with Two Reversible Door Stops

Item#	Finish	Material
CP70-CH	Chrome	Aluminum & SUS304
CP70-BN	Brushed Nickel	
CP70-MBL	Matte Black	

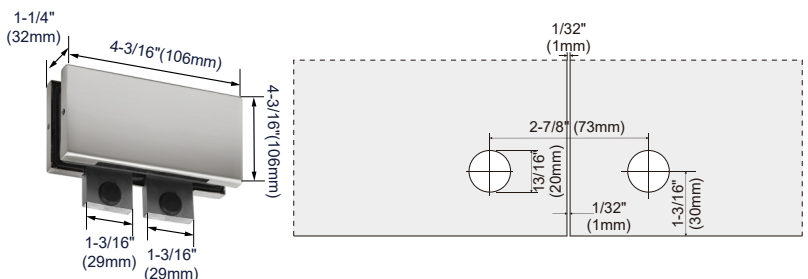

Tempered Glass
 3/8"-1/2"
 176lbs
 42"

Bottom Door Patch with 301 Insert

Item#	Finish	Material
CP10-301-CH	Chrome	Aluminum & SUS304
CP10-301-BN	Brushed Nickel	
CP10-301-MBL	Matte Black	

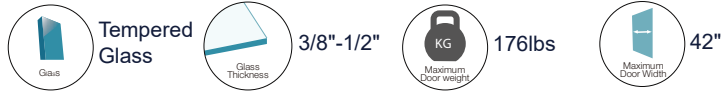
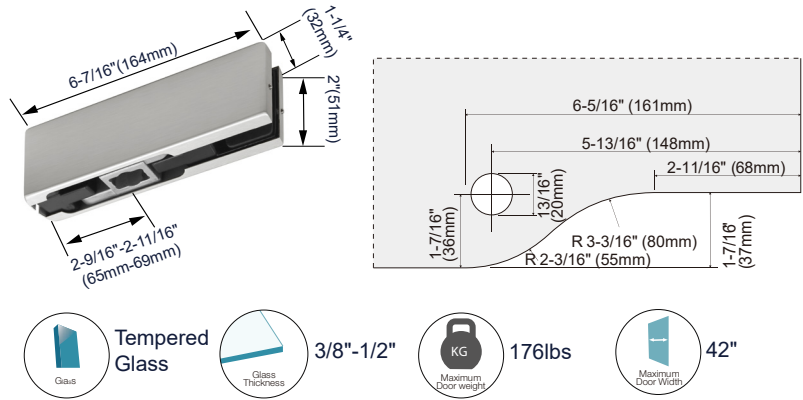

Adjustable Free-Swinging Bottom Pivot

Item#	Finish	Material
CP-403-BN	Brushed Nickel	Aluminum & SUS304
CP-403-MBL	Matte Black	
CP-403-SA	Satin Anodized	

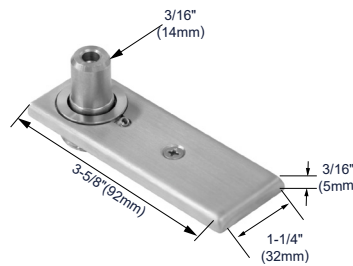

The CP-403 is required for use with the CP10-301

Top Door Patch with 303 Insert

Item#	Finish	Material
CP20-303-CH	Chrome	Aluminum & SUS304
CP20-303-BN	Brushed Nickel	
CP20-303-MBL	Matte Black	

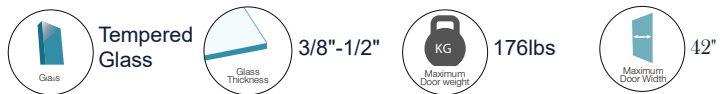
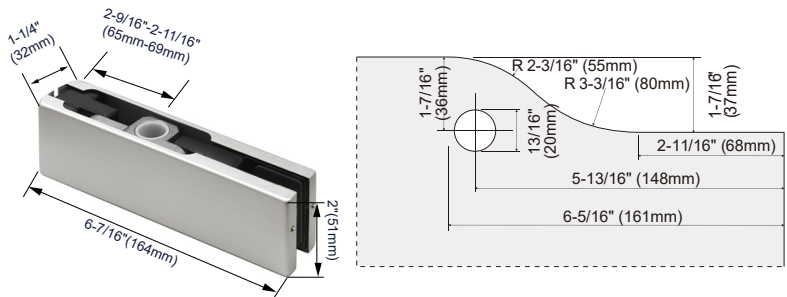

Adjustable Spring Power 90 Degree Hold Open Floor Mounted Closer

Item#	Material
CFDC150-ADJ	Steel & Stainless Steel

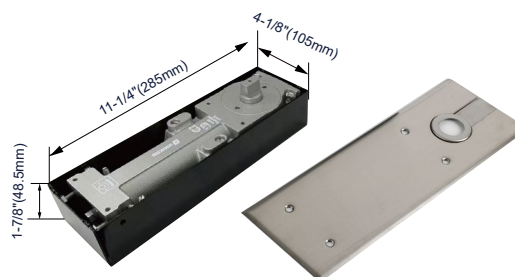

Product Overview

- For 3/8" or 1/2" (10 or 12 mm) glass
- To ensure public safety, we strongly advise using only tempered safety glass.
- Available in four finishes
- Option to include or exclude locks



Item#		Description
CP34-300		Wall Mounted Transom Patch with 300 Insert
CHFH		Commercial - Hydraulic Floor Hinge Fit For 5/16"-1/2" Glass With Hold Open At 90° Up To 150°
CP205		Bottom Patch Lock
CHLL48X48		Ladder Pull Back-to-Back Handle with Lock-48"
CHLL60X60		Ladder Pull Back-to-Back Handle with Lock-60"
CHLP36X36		36" Ladder Pull Back-to-Back Handle
CHLP48X48		48" Ladder Pull Back-to-Back Handle
CHLP60X60		60" Ladder Pull Back-to-Back Handle
CHLP72X72		72" Ladder Pull Back-to-Back Handle
CD-10-OT		10" Offset Back-to-Back Pull Handle

Wall Mounted Transom Patch with 300 Insert		
Item#	Finish	Material
CP34-300-CH	Chrome	Aluminum & SUS304
CP34-300-BN	Brushed Nickel	
CP34-300-MBL	Matte Black	

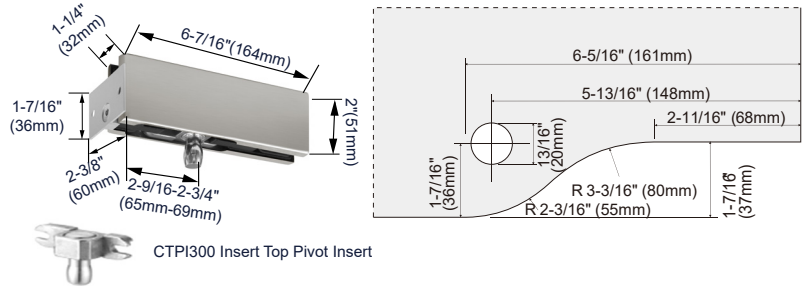

Tempered Glass 3/8"-1/2" 176lbs 42"

Top And Hydraulic Bottom Patch Fitting Set with Top Pivot and Base		
Item#	Finish	Material
CHFH-CH	Chrome	Aluminum & SUS304
CHFH-BN	Brushed Nickel	
CHFH-MBL	Matte Black	

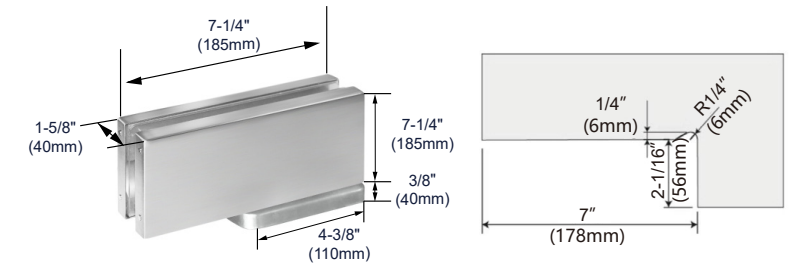

Tempered Glass 5/16"-1/2" 220.46lbs 37-3/8"

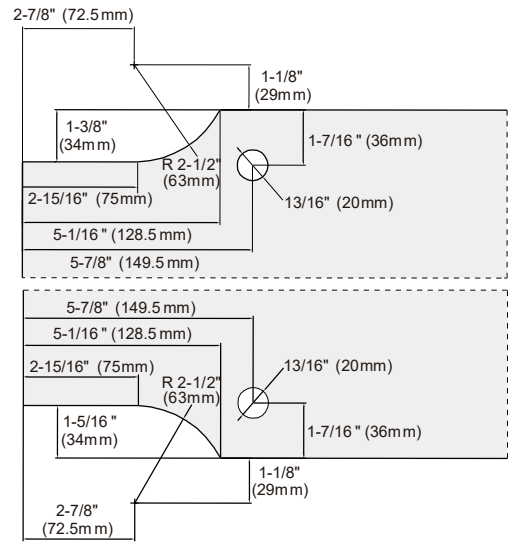
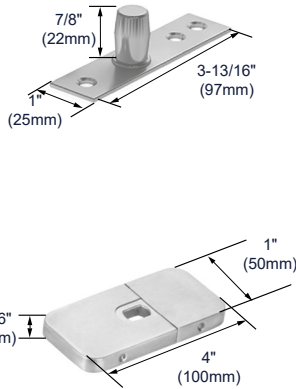
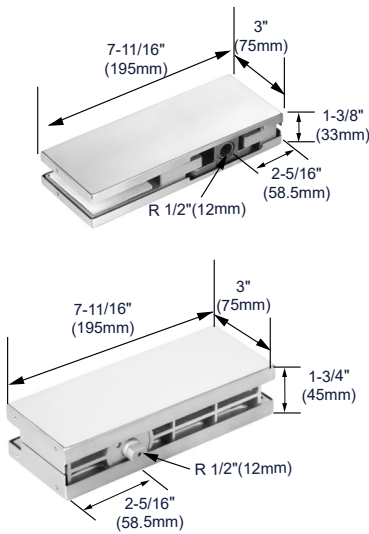

Bottom Patch Lock		
Item#	Finish	Material
CP205-CH	Chrome	Aluminum & SUS304
CP205-BN	Brushed Nickel	
CP205-MBL	Matte Black	

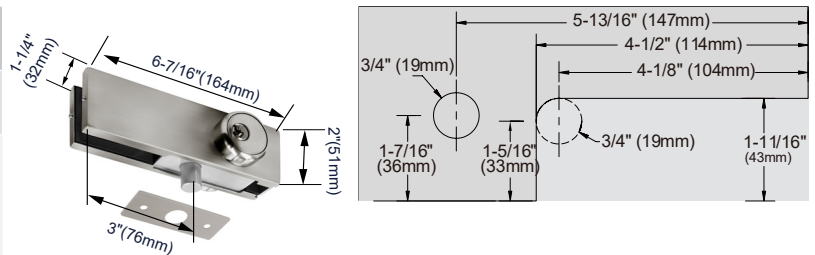

Tempered Glass 3/8"-1/2" 176lbs 42"

Product Overview

- For 3/8" or 1/2" (10 or 12 mm) glass
- To ensure public safety, we strongly advise using only tempered safety glass.
- Available in four finishes
- Option to include or exclude locks

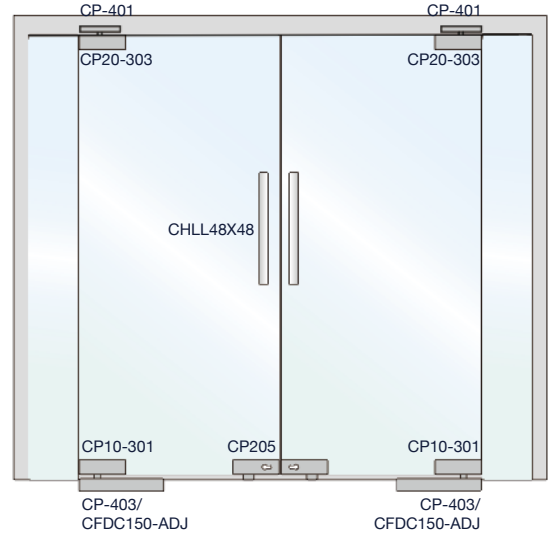

Item#		Description
CP10-301		Bottom Door Patch with 301 Insert
CP-403		Adjustable Free-Swinging Bottom Pivot
CP20-303		Top Door Patch with 303 Insert
CP-401		Top Center-Hung Free Swing Pivot
CP205		Bottom Patch Lock
CFDC150-ADJ		Adjustable Spring Power 90 Degree Hold Open Floor Mounted Closer
CHLL48X48		Ladder Pull Back-to-Back Handle with Lock-48"
CHLL60X60		Ladder Pull Back-to-Back Handle with Lock-60"
CHLP36X36		36" Ladder Pull Back-to-Back Handle
CHLP48X48		48" Ladder Pull Back-to-Back Handle
CHLP60X60		60" Ladder Pull Back-to-Back Handle
CHLP72X72		72" Ladder Pull Back-to-Back Handle
CD-10-OT		10" Offset Back-to-Back Pull Handle

Bottom Door Patch with 301 Insert

Item#	Finish	Material
CP10-301-CH	Chrome	Aluminum & SUS304
CP10-301-BN	Brushed Nickel	
CP10-301-MBL	Matte Black	
CP10-301-SA	Satin Anodized	

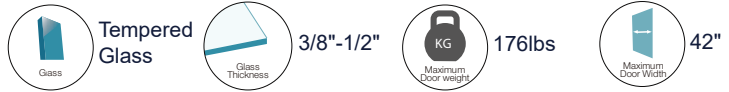
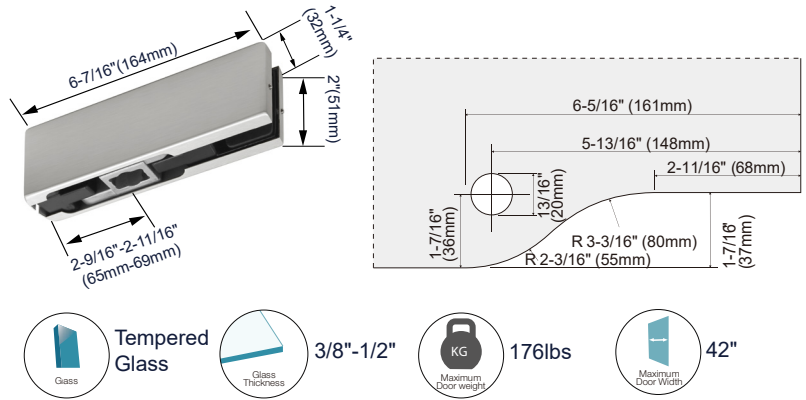

Adjustable Free-Swinging Bottom Pivot

Item#	Finish	Material
CP-403-BN	Brushed Nickel	Aluminum & SUS304
CP-403-MBL	Matte Black	
CP-403-SA	Satin Anodized	

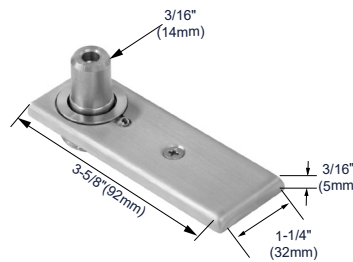

The CP-403 is required for use with the CP10-301

Top Door Patch with 303 Insert

Item#	Finish	Material
CP20-303-CH	Chrome	Aluminum & SUS304
CP20-303-BN	Brushed Nickel	
CP20-303-MBL	Matte Black	

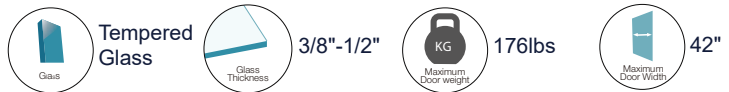
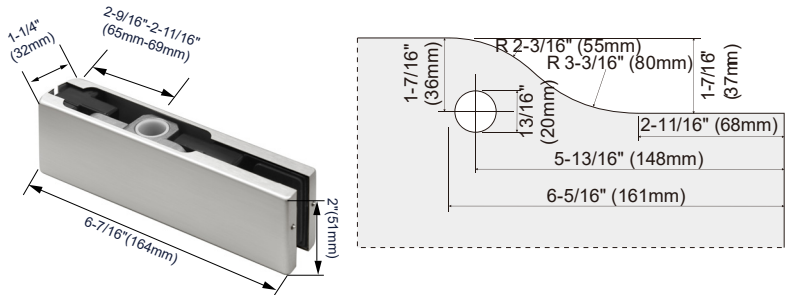

Top Center-Hung Free Swing Pivot

Item#	Finish	Material
CP-401-BN	Brushed Nickel	Aluminum & SUS304
CP-401-MBL	Matte Black	

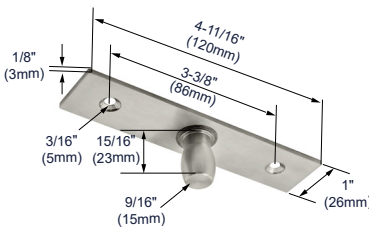

The CP-401 is required for use with the CP20-303

Bottom Patch Lock		
Item#	Finish	Material
CP205-CH	Chrom	Aluminum & SUS304
CP205-BN	Brushed Nickel	
CP205-MBL	Matte Black	

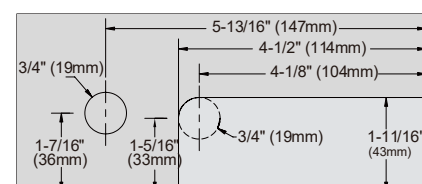
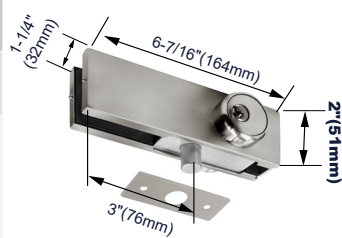

- Tempered Glass
- 3/8" - 1/2"
- 176lbs
- 42"

Adjustable Spring Power 90 Degree Hold Open Floor Mounted Closer	
Item#	Material
CFDC150-ADJ	Steel & Stainless Steel

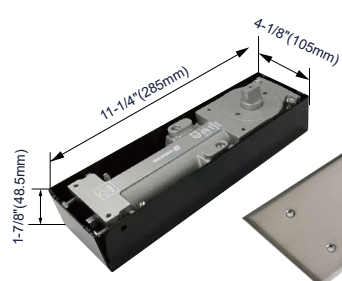

- Tempered Glass
- 3/8" - 1/2"
- 330.7lbs
- 23-5/8" - 43-5/16"

Product Overview

- For 3/8" or 1/2" (10 or 12 mm) glass
- To ensure public safety, we strongly advise using only tempered safety glass.
- Option to include or exclude locks

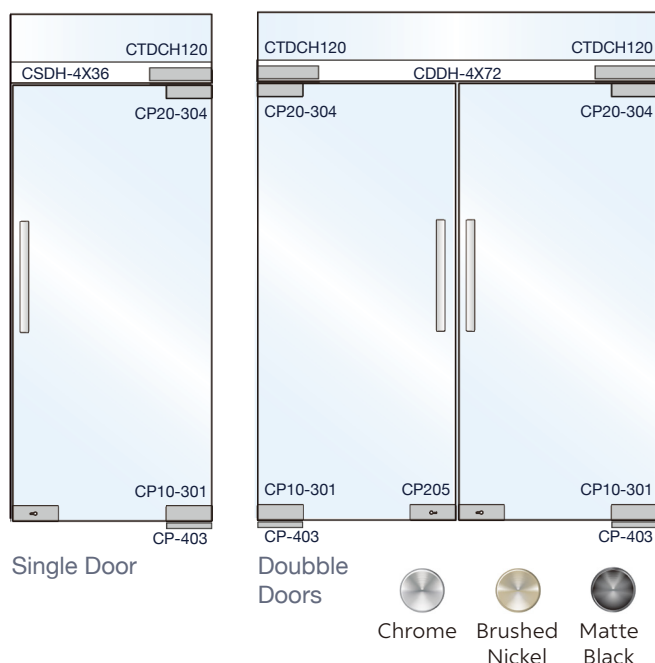

Item#		Description
CTDCH120		Heavy-Duty 90 Degree Hold open Overhead Concealed Door Closer
CDDH-4X72		4"X72" Aluminum Double Door Header W/304ss Covers
CP205		Bottom Patch Lock
CP20-304		Top Patch Fitting With Insert
CP10-301		Bottom Door Patch with 301 Insert
CP-403		Adjustable Free-Swinging Bottom Pivot
CHLL48X48		Ladder Pull Back-to-Back Handle with Lock-48"
CHLL60X60		Ladder Pull Back-to-Back Handle with Lock-60"
CHLP36X36		36" Ladder Pull Back-to-Back Handle
CHLP48X48		48" Ladder Pull Back-to-Back Handle
CHLP60X60		60" Ladder Pull Back-to-Back Handle
CHLP72X72		72" Ladder Pull Back-to-Back Handle
CD-10-OT		10" Offset Back-to-Back Pull Handle
CSDH-4X36		4"X36" Aluminum Single Door Header W/304ss Covers

Sidelite Mounted Transom Patch with Reversible Door Stop

Item#	Material
CTDCH120	Steel & Stainless steel

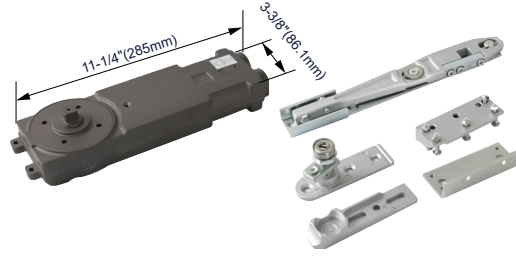

Tempered Glass
 Glass Thickness 3/8"-1/2"
 Maximum Door weight 176lbs
 Maximum Door Width 42"

4"X72" Aluminum Double Door Header W/304ss Covers

Item#	Finish	Material
CDDH-4X72-BN	Brushed Nickel	Aluminum
CDDH-4X72-MBL	Matte Black	
CDDH-4X72-SA	Satin Anodized	



Tempered Glass
 Glass Thickness 3/8"-1/2"

Wall Mounted Transom Patch with 300 Insert

Item#	Finish	Material
CP20-304-CH	Chrome	Aluminum & SUS304
CP20-304-BN	Brushed Nickel	
CP20-304-MBL	Matte Black	

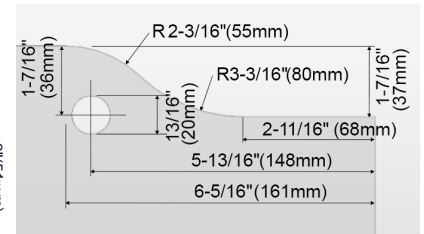
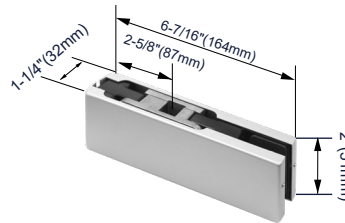

Tempered Glass
 Glass Thickness 3/8"-1/2"
 Maximum Door weight 176lbs
 Maximum Door Width 42"

Bottom Patch Lock

Item#	Finish	Material
CP205-CH	Chrom	Aluminum & SUS304
CP205-BN	Brushed Nickel	
CP205-MBL	Matte Black	

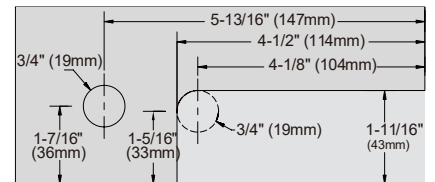
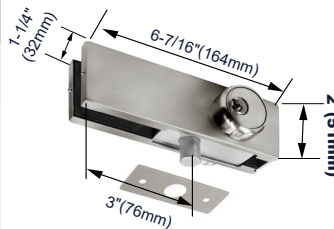

Tempered Glass
 Glass Thickness 3/8"-1/2"
 Maximum Door weight 176lbs
 Maximum Door Width 42"

Bottom Door Patch with 301 Insert

Item#	Finish	Material
CP10-301-CH	Chrome	Aluminum & SUS304
CP10-301-BN	Brushed Nickel	
CP10-301-MBL	Matte Black	

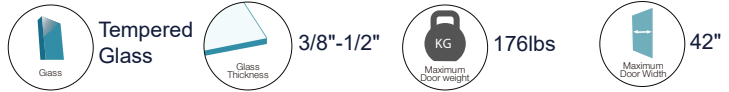
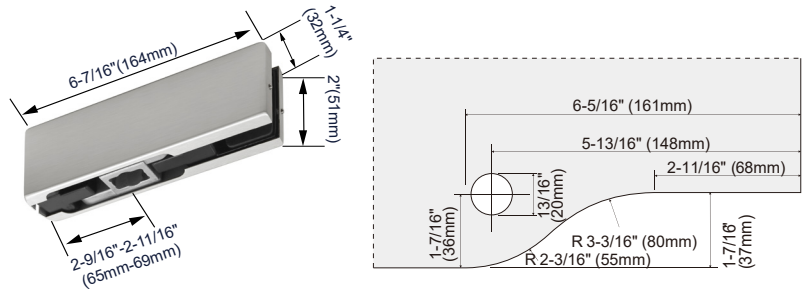

Adjustable Free-Swinging Bottom Pivot

Item#	Finish	Material
CP-403-BN	Brushed Nickel	Aluminum & SUS304
CP-403-MBL	Matte Black	
CP-403-SA	Satin Anodized	

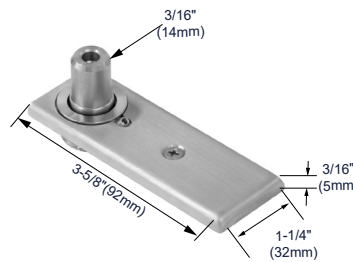

The CP-403 is required for use with the CP10-301

4"X36" Aluminum Single Door Header W/304ss Covers

Item#	Finish	Material
CSDH-4X36-BN	Brushed Nickel	Aluminum
CSDH-4X36-MBL	Matte Black	
CSDH-4X36-SA	Satin Anodized	



Product Overview

- For 3/8" or 1/2" (10 or 12 mm) glass
- To ensure public safety, we strongly advise using only tempered safety glass.
- Available in four finishes
- Option to include or exclude locks

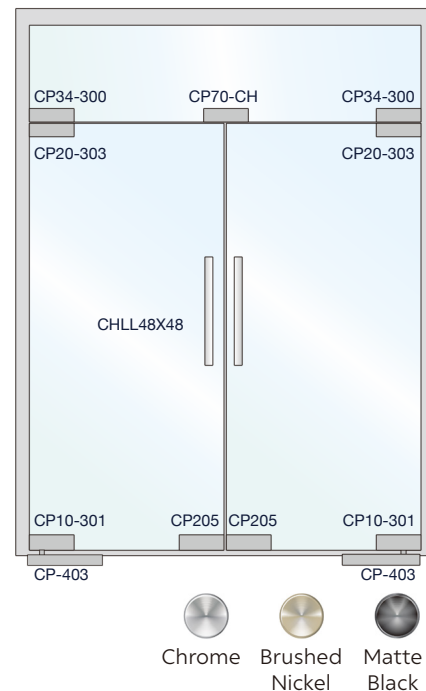

Item#		Description
CP70		Transom Mounted Connector with Two Reversible Door Stops
CP10-301		Bottom Door Patch with 301 Insert
CP-403		Sidelite Transom Patch with 300 Insert
CP20-303		Top Door Patch with 303 Insert
CP-401		Top Center-Hung Free Swing Pivot
CP205		Bottom Patch Lock
CP34-300		Wall Mounted Transom Patch with 300 Insert
CHLL48X48		Ladder Pull Back-to-Back Handle with Lock-48"
CHLL60X60		Ladder Pull Back-to-Back Handle with Lock-60"
CHLP36X36		36" Ladder Pull Back-to-Back Handle
CHLP48X48		48" Ladder Pull Back-to-Back Handle
CHLP60X60		60" Ladder Pull Back-to-Back Handle
CHLP72X72		72" Ladder Pull Back-to-Back Handle
CD-10-OT		10" Offset Back-to-Back Pull Handle

Transom Mounted Connector with Two Reversible Door Stops

Item#	Finish	Material
CP70-CH	Chrome	Aluminum & SUS304
CP70-BN	Brushed Nickel	
CP70-MBL	Matte Black	

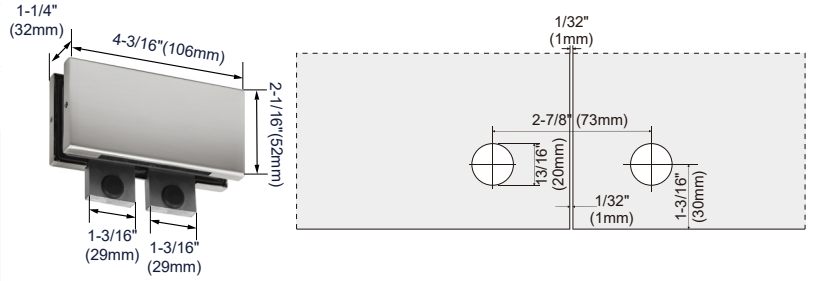

Tempered Glass
 3/8"-1/2"
 176lbs
 42"

Bottom Door Patch with 301 Insert

Item#	Finish	Material
CP10-301-CH	Chrome	Aluminum & SUS304
CP10-301-BN	Brushed Nickel	
CP10-301-MBL	Matte Black	

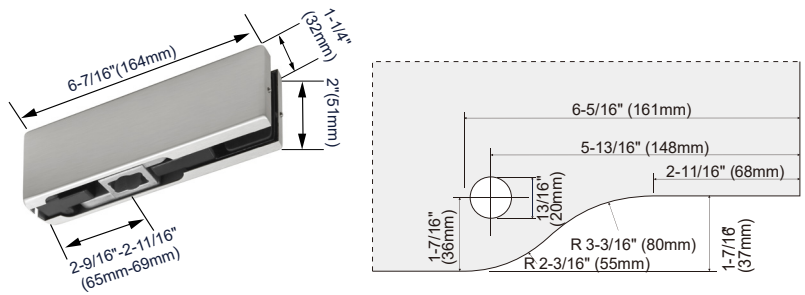

Tempered Glass
 3/8"-1/2"
 176lbs
 42"

Adjustable Free-Swinging Bottom Pivot

Item#	Finish	Material
CP-403-BN	Brushed Nickel	Aluminum & SUS304
CP-403-MBL	Matte Black	
CP-403-SA	Satin Anodized	



The CP-403 is required for use with the CP10-301

Top Door Patch with 303 Insert

Item#	Finish	Material
CP20-303-CH	Chrome	Aluminum & SUS304
CP20-303-BN	Brushed Nickel	
CP20-303-MBL	Matte Black	

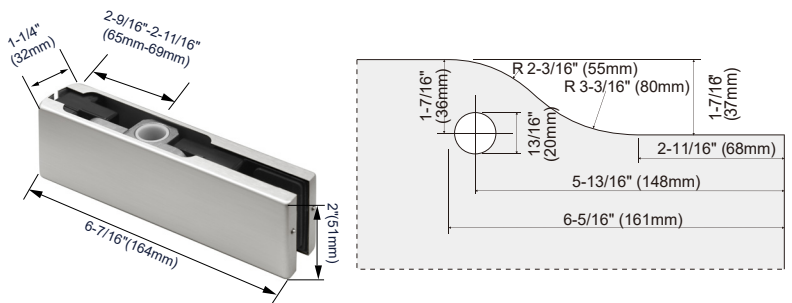

Tempered Glass
 3/8"-1/2"
 176lbs
 42"

Top Center-Hung Free Swing Pivot

Item#	Finish	Material
CP-401-BN	Brushed Nickel	Aluminum & SUS304
CP-401-MBL	Matte Black	

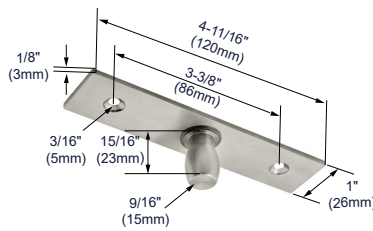

The CP-401 is required for use with the CP20-303

Bottom Patch Lock

Item#	Finish	Material
CP205-CH	Chrome	Aluminum & SUS304
CP205-BN	Brushed Nickel	
CP205-MBL	Matte Black	

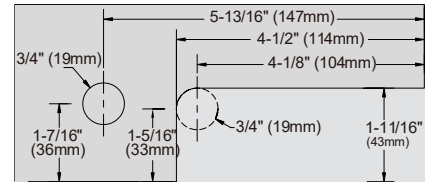
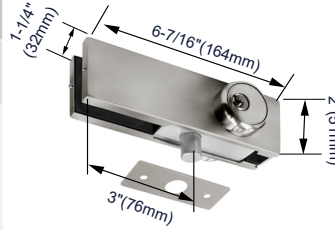

- Tempered Glass
- 3/8"-1/2"
- 176lbs
- 42"

Wall Mounted Transom Patch with 300 Insert

Item#	Finish	Material
CP34-300-CH	Chrome	Aluminum & SUS304
CP34-300-BN	Brushed Nickel	
CP34-300-MBL	Matte Black	

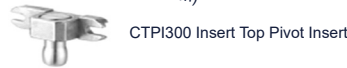
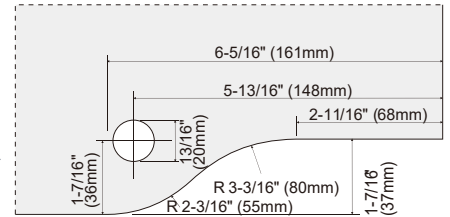
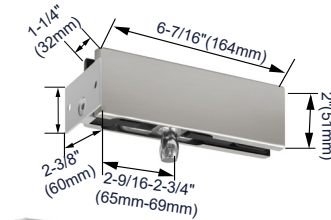

- Tempered Glass
- 3/8"-1/2"
- 176lbs
- 42"





Product Overview

- For 3/8" or 1/2" (10 or 12 mm) glass
- Available in four finishes
- To ensure public safety, we strongly advise using only tempered safety glass.

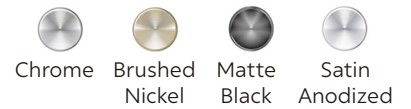
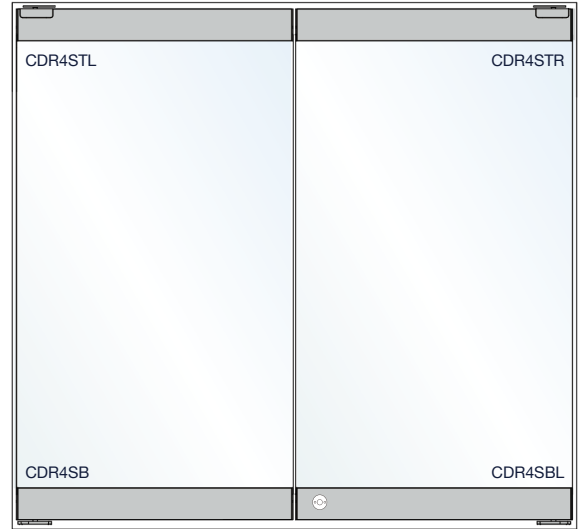

Item#		Description
CDR4STL		3/8"-1/2" Glass 4" Square Door Rail with Top Swing Pivot Left Handed From Interior View
CDR4STR		3/8"-1/2" Glass 4" Square Door Rail with Top Swing Pivot Right Handed From Interior View
CDR4SB		3/8"-1/2" Glass 4" Square Door Rail with Bottom Base Plate without Lock
CDR4SBL		3/8"-1/2" Glass 4" Square Door Rail with Bottom Base Plate with Lock

3/8"-1/2" Glass 4" Square Door Rail with Top Swing Pivot Left Handed From Interior View

Item#	Finish	Material
CDR4STL-CH	Chrome	Aluminum & SUS304
CDR4STL-BN	Brushed Nickel	
CDR4STL-MBL	Matte Black	
CDR4STL-SA	Satin Anodized	

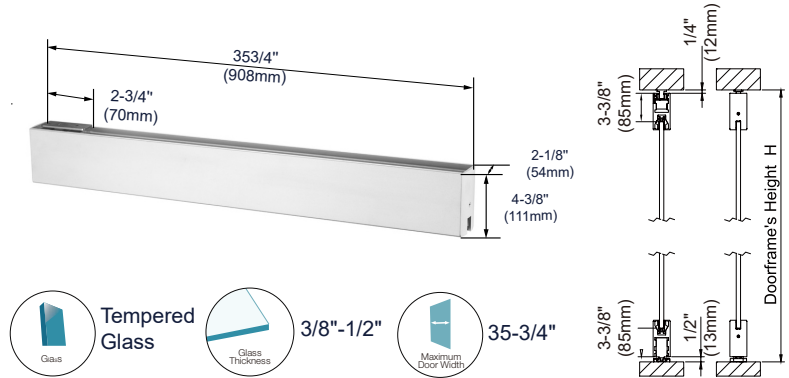

3/8"-1/2" Glass 4" Square Door Rail with Top Swing Pivot Right Handed From Interior View

Item#	Finish	Material
CDR4STR-CH	Chrome	Aluminum & SUS304
CDR4STR-BN	Brushed Nickel	
CDR4STR-MBL	Matte Black	
CDR4STR-SA	Satin Anodized	

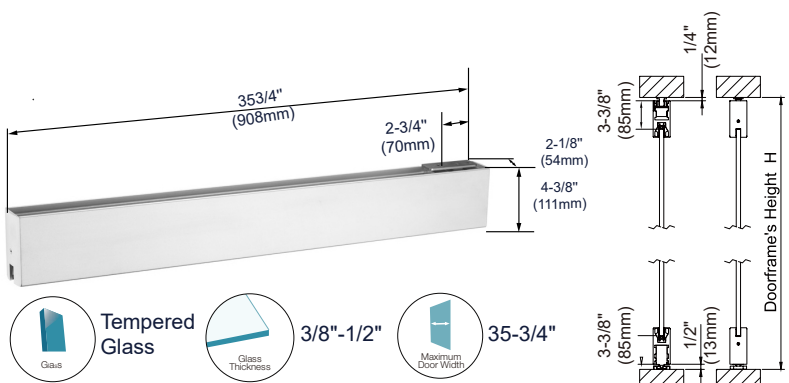

3/8"-1/2" Glass 4" Square Door Rail with Bottom Base Plate without Lock

Item#	Finish	Material
CDR4SB-CH	Chrome	Aluminum & SUS304
CDR4SB-BN	Brushed Nickel	
CDR4SB-MBL	Matte Black	
CDR4SB-SA	Satin Anodized	

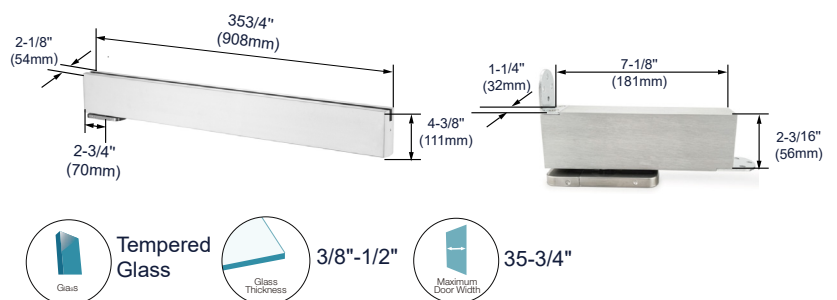

3/8"-1/2" Glass 4" Square Door Rail with Bottom Base Plate with Lock

Item#	Finish	Material
CDR4SBL-CH	Chrome	Aluminum & SUS304
CDR4SBL-BN	Brushed Nickel	
CDR4SBL-MBL	Matte Black	
CDR4SBL-SA	Satin Anodized	

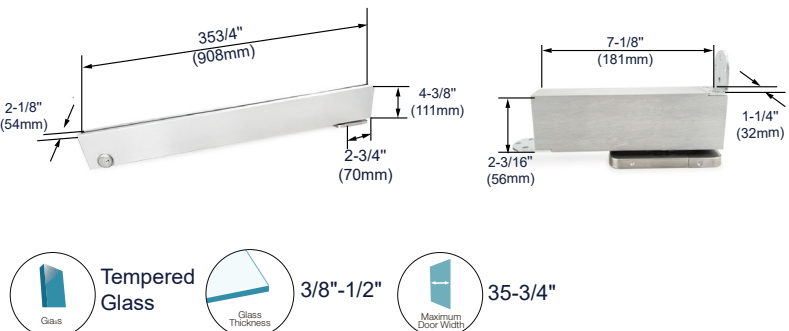



LL-20MG Magnetic Glass Lever Lock

- Designed for glass panel
- Low noise operation
- Spring force adjustable
- Suitable for glass thickness 5/16"~3/8"
- 5/8" and 11/16" handle holder for options
- DIN Left to Right side is changeable
- Suitable for a narrow frame

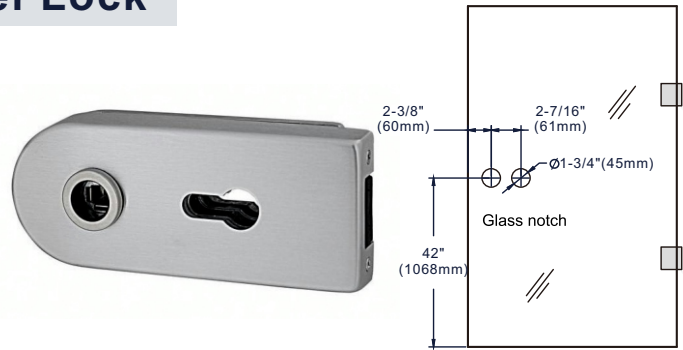

LL-20MG Magnetic Glass Lever Lock



LL-20MH Magnetic holder preparation

For a wooden frame hole dimension is L:1-7/16" W:5/8" D:17/32"

For an aluminum frame hole dimension is L:1-7/16" W:5/8"

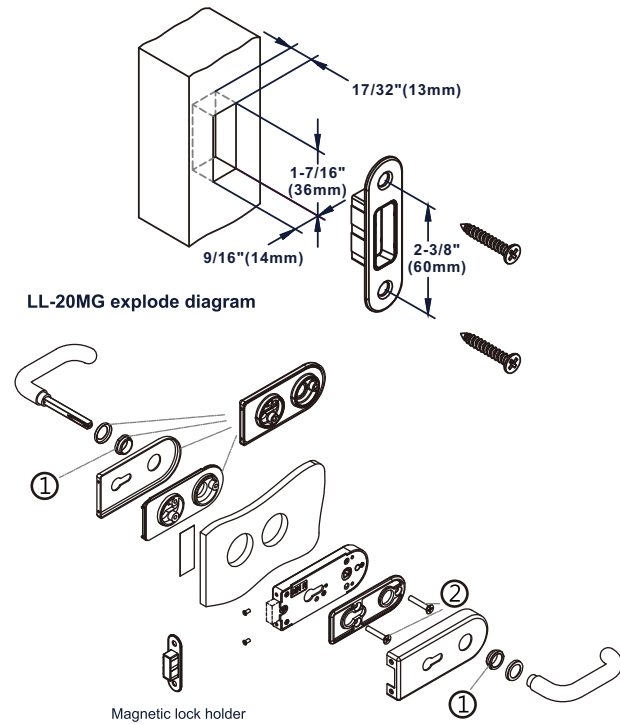

LLD-207 Lever Handle

- **Material** : Drop-Forged Aluminium Alloy
- With 5/16" square spindle for all ever locks
- **Finish** : MS : Anodized-Mat silver
MB : Anodized-Mat Brass
SNK: Anodized Similar as satin stainless steel



9125ST-BK/SC

- Europrofile cylinder
- Pre-configured for lever lock installation
- Key on one side and thumbturn on the other side
- Material : Solid Brass



Black Cover



Satin Chrome



Lh86-MBK/MS

- Lever hinge
- For 5/16" - 3/8" glass



Anodized Mat Black



Anodized Mat Silver



Applications 1. Office Door 2. Living Room Door

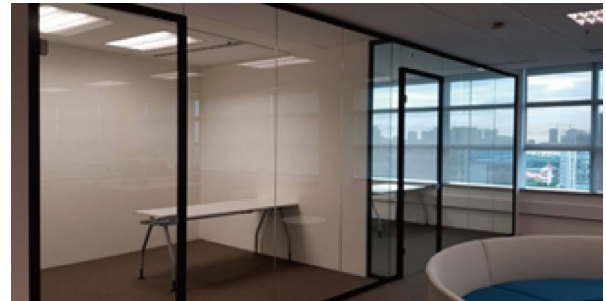

LH86.2-SSS/PSS/MBK

- 180° Glass to Glass
- For 5/16" - 3/8" glass



Stainless Steel



Polished Stainless Steel



Anodized Mat Black

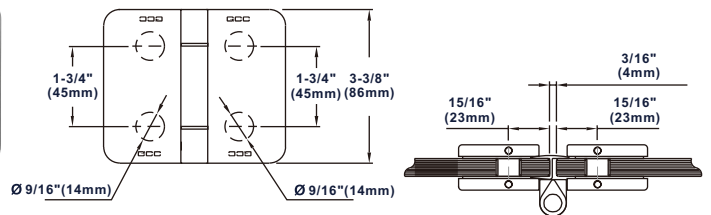

LH86.4-SSS/PSS/MBK

- 90° Glass to Glass
- For 5/16" - 3/8" glass



Stainless Steel



Polished Stainless Steel



Anodized Mat Black

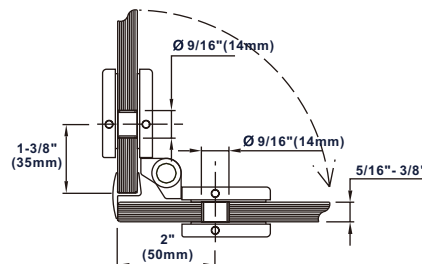

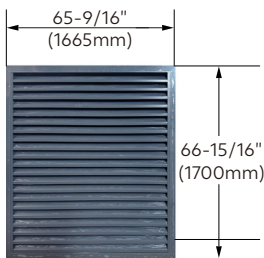

Aluminum Assembled Louver Fence Panel

Height	Width	Thickness
66-15/16"(1700mm)	65-9/16"(1665mm)	2"(50mm)

AALF7272-MBL

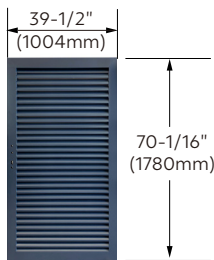

Aluminum Louver Swing Gate Panel

Height	Width	Thickness
70-1/16"(1780mm)	39-1/2"(1004mm)	2"(50mm)

AALFG4872-MBL



Fence Post

Height	Square
72-1/25"(1830mm)	3-1/4"(82.5mm)* 3-1/4"(82.5mm)

FP72-01-MBL

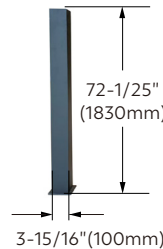

Fence Gate Post

Height	Square
72-1/25"(1830mm)	3-15/16"(100mm)* 3-15/16"(100mm)

PFG72-01-MBL

Fence Gate Lock



LFG01-MBL

- Feature a modern design and are easy to install, making them a DIY-friendly solution.
- Built to endure extreme weather conditions, they can withstand high winds without being easily toppled.
- Provide an ideal blend of privacy and security while allowing for adequate airflow.
- For optimal stability and performance, installation on a concrete surface is recommended.

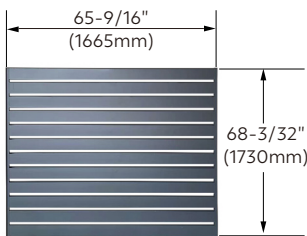

Aluminum Assembled Slat Fence Panel

Height	Width	Thickness
68-3/32"(1730mm)	65-9/16"(1665mm)	2"(50mm)

AASF7272-MBL

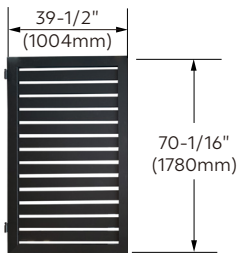

Aluminum Louver Swing Gate Panel

Height	Width	Thickness
70-1/16"(1780mm)	39-1/2"(1004mm)	2"(50mm)

AASFG4872-MBL



Fence Post

Height	Square
72-1/25"(1830mm)	3-1/4"(82.5mm)* 3-1/4"(82.5mm)

FP72-01-MBL

3-1/4"(82.5mm)



Fence Gate Post

Height	Square
72-1/25"(1830mm)	3-15/16"(100mm)* 3-15/16"(100mm)

PFG72-01-MBL

3-15/16"(100mm)

Fence Gate Lock



LFG01-MBL

- Feature a modern design and are easy to install, making them a DIY-friendly solution.
- Built to endure extreme weather conditions, they can withstand high winds without being easily toppled.
- Provide an ideal blend of privacy and security while allowing for adequate airflow.
- For optimal stability and performance, installation on a concrete surface is recommended.

Wooden Slat Wall Panel

CWSWP9423

For Interior Only

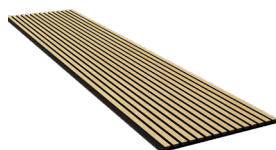

CWSW9423-YO

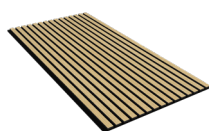

CWSW4723-YO

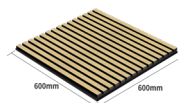

CWSW2323-YO

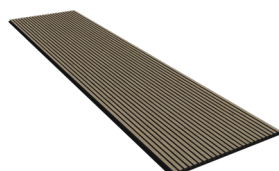
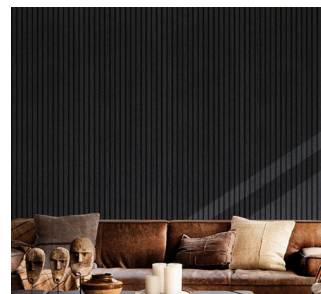

CWSW9423-WN

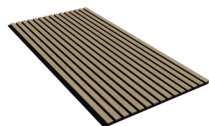

CWSW4723-WN



CWSW2323-WN

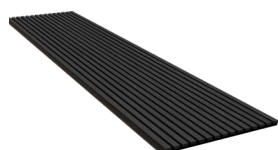

CWSW9423-BO

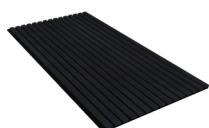

CWSW4723-BO



CWSW2323-BO

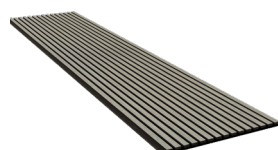

CWSW9423-GO

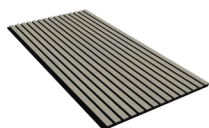

CWSW4723-GO

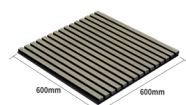

CWSW2323-GO

Finishes: Yellow Oak / Walnut / Back Oak / Grey Oak

Height	Length	Width	Pack Quantity
13/16 in. (21 mm)	94-1/2 in. (2400 mm)	23-5/8 in. (600 mm)	2 panels per pack
13/16 in. (21 mm)	47-1/4"(1200mm)	23-5/8 in. (600 mm)	2 panels per pack
13/16 in. (21 mm)	23-5/8"(600mm)	23-5/8 in. (600 mm)	2 panels per pack

Material

1/2”(12mm) Eco- Friendly Medium Density Fiberboard

- The acoustical felt is made from recycled materials and is certified under the Global Recycle Standards (GRS). The wood slats are constructed from Medium Density Fiberboard (MDF), certified by the Forest Stewardship Council (FSC).
- The base consists of a 3/8” thick polyester panel, topped with 1/2” thick MDF slats. Each slat measures 1-1/16” in width, with a spacing of approximately 17/32” between them.
- Designed to improve sound quality and bring a sophisticated aesthetic, these wooden slat panels are ideal for both walls and ceilings. Their simple installation process and a range of color options provide limitless design opportunities.



LOS ANGELES

4610 Santa Anita Ave, El Monte, CA 91731 | 626.522.1551 | info@unikoogroup.com

ORANGE COUNTY

1820 S Santa Fe St, Santa Ana, CA 92705 | 888.404.5533 | infooc@unikoogroup.com

NEW JERSEY

1090 Lousons Rd, Union, NJ 07083 | 908-969-1908 | infonj@unikoogroup.com

www.unikoogroup.com